



# QUICK-CHECK 6 PORT POWERSAVER MANIFOLD O&M MANUAL

Revision 0

Date 8/02/17



---

**PROPRIETARY NOTICE:** All information herein is the property of South-Tek Systems and must be kept confidential and not be disclosed without South-Tek's agreement nor used, in whole or in part, in manufacturing or selling gas separation equipment without the express written permission of South-Tek. South-Tek Systems authorizes the necessary and reasonable use of this document, and information herein, solely for the evaluation, installation, operation, and maintenance of South-Tek's Nitrogen Generators and Accessories. No other use is authorized.

# VERSION HISTORY

| Rev # | Revised By   | Revision Date | Approved By | Approval Date | Reason |
|-------|--------------|---------------|-------------|---------------|--------|
| 00    | Kyle Mellott | 6/2/17        | J. Nguyen   | 8/02/17       |        |
|       |              |               |             |               |        |
|       |              |               |             |               |        |
|       |              |               |             |               |        |

User password: 6557

PLC Name: QCP

General Arrangement Drawing #: A02-QCF-PS6PM-TI, QUICK-CHECK 6 PORT, TYPICAL INSTALLATION, (R02)

Electrical Schematic Drawing #: ES-QCF-PS06PM, QUICK-CHECK 6 PORT, ELECTRICAL SCHEMATIC, (R07)

Other Documentation(s):

---



---



---



---



---



---



---

Service or Questions Contact:

South-Tek Systems Service Department

2940 Orville Wright Way, Wilmington, NC 28405

Phone: 1-(888)-526-6284, Ext. 127

Email: [info@southteksystems.com](mailto:info@southteksystems.com) or [service@southteksystems.com](mailto:service@southteksystems.com)

Visit: [www.southteksystems.com](http://www.southteksystems.com)

-----Notes Page-----

# TABLE OF CONTENTS

- 1 INTRODUCTION ..... 6**
  - 1.1 Purpose ..... 6
  - 1.2 About South-Tek Systems ..... 6
  - 1.3 Audience ..... 6
  - 1.4 Limits of Liability ..... 7
  - 1.5 Service Return Policy ..... 7
- 2 SAFETY GUIDELINES ..... 7**
  - 2.1 General Safety Practices ..... 8
  - 2.2 Safety Information ..... 8
- 3 PRODUCT INSTALLATION ..... 9**
  - 3.1 Unpacking and Preparation ..... 9
  - 3.2 Storage Instructions ..... 10
  - 3.3 Electrical Requirements ..... 10
- 4 SYSTEM DESCRIPTION ..... 10**
  - 4.1 Key Features ..... 10
  - 4.2 Specifications ..... 12
- 5 SYSTEM CONTROLS AND COMMUNICATIONS ..... 12**
  - 5.1 Home Screen ..... 13
  - 5.2 Powering On/Off ..... 13
  - 5.3 HMI Input Functions ..... 13
  - 5.4 Menu Screen ..... 14
  - 5.5 Sensor Setup/Calibration ..... 15
  - 5.6 Alarms/Filter Parameters ..... 16
  - 5.7 Zone History ..... 18
  - 5.8 Communication Settings for Ethernet Connection (optional) ..... 18
- 6 READING THE QUICK-CHECK ZONE STATUS ..... 20**
  - 6.1 Zone Purity Status ..... 20
  - 6.2 Zone Flow Status ..... 21
  - 6.3 Current Mode ..... 21
  - 6.4 Alarm Status ..... 21
  - 6.5 Zone Setup ..... 21
- 7 QUICK-CHECK-POWERSAVER MANIFOLD OPERATIONS AND START-UP ..... 22**
  - 7.1 Start-up ..... 22
    - 7.1.1 Initial Start-Up ..... 22
    - 7.1.2 Initial System Purge ..... 23

7.1.3 Normal Start-up.....23

7.2 Shutdown.....24

**8 SYSTEM MAINTENANCE.....24**

8.1 Filter Element Replacement.....24

8.2 Maintenance Screen.....25

8.2.1 Maintenance Test.....25

8.2.2 Valve Test Mode.....25

**9 AUTOPURGE SYSTEM TUNING.....26**

**10 FAQs.....27**

**11 KEY CONTACTS.....28**

**APPENDIX A: WARRANTY .....28**

# 1 INTRODUCTION

## 1.1 PURPOSE

This operational manual is provided for instructional purposes of the South-Tek Systems Quick-Check™- PowerSaver Manifold only. It is intended to provide proper installation and normal operational use of the device. South-Tek Systems is not responsible for damages concerning the use of this device when used in manners not approved by South-Tek Systems. The user(s) of this document should confer any questions with a qualified South-Tek Systems representative with respect to its commissioning and correct operational use.

Please contact South-Tek Systems with any question or concerns at:

South-Tek Systems, LLC  
2940 Orville Wright Way Ste 600  
Wilmington, NC, 28405

Tel: (888) 526-6284  
Email: [Info@southteksystems.com](mailto:Info@southteksystems.com)  
<http://www.southteksystems.com/>

This document is based upon the R&D performed by the South-Tek Systems Engineering Team.

## 1.2 ABOUT SOUTH-TEK SYSTEMS

South-Tek Systems, founded in 1997, is a nitrogen generator manufacturer, designing and producing nitrogen generating systems for worldwide distribution.

Why not generate nitrogen at your own facility for a fraction of the cost versus endlessly paying for bulk liquid or delivered gas cylinders? We manufacture a full line of nitrogen generating equipment including:

- [The N<sub>2</sub> GEN<sup>®</sup> Series](#) Nitrogen generators for use in various industrial and lab applications. 50,000 SCFH unit.
- [The BeerBlast™ - Mixed Gas Dispense System](#) Increases profits, eliminates over or under carbonation, and improves all-around taste and draft beer quality.
- [The N<sub>2</sub>-Blast<sup>®</sup> - Corrosion Inhibiting System](#) Effectively arrests electrochemical, galvanic and micro-biologically influenced corrosion (MIC) by introducing 99.9995% pure nitrogen into dry and preaction sprinkler systems.

With purities ranging from 95% up to 99.999%, we provide nitrogen generators that are sure to suit your needs. For more information about our complete nitrogen generator capabilities, please visit [www.southteksystems.com](http://www.southteksystems.com).

## 1.3 AUDIENCE

This manual is intended for Installer/Equipment Operator/Supervisory Staff and should be read in its entirety prior to operation. Please contact South-Tek Systems for any operation and maintenance questions. Please contact your local distributor provider for any operation and maintenance first prior to contacting the manufacturer.

## 1.4 LIMITS OF LIABILITY

Buyer's exclusive remedy for all claims shall be for damages, and seller's total liability for any and all losses and damages arising out of any cause whatsoever including, without limitation, defects in or defective performance of the system, (whether such claim be based in contract, negligence, strictly liability, other tort or otherwise) shall in no event exceed the purchase price of the system in respect of which such cause arises or, at seller's option, the repair or replacement of such; and in no event shall seller be liable for incidental, consequential or punitive damages resulting from any such cause.

Seller shall not be liable for, and Buyer assumes all liability for, the suitability and the results of using nitrogen by itself or in any manufacturing or other industrial process or procedure, all personal injury and property damages connected with the possession, operation, maintenance, other use or resale of the System. Transportation charges for the return of the System shall not be paid unless authorized in advance by Seller.

NOTE: Any MODIFICATIONS made by the customer without the written consent of South-Tek Systems will void the product's design specifications.

## 1.5 SERVICE RETURN POLICY

If the system cannot be repaired at the site, and it is necessary to return a system for service, the following procedures must be followed:

- The owner must obtain a written **Return Material Authorization** number, which references the model and serial number, from South-Tek Systems. No items will be accepted for service or credit unless prior written authorization has been issued by South-Tek Systems.
- All items are to be returned with the original packaging material if possible. Make sure that all items are packaged for safe return to South-Tek Systems. South-Tek Systems will not be responsible for damages, which occur in transit. Any damage that occurs to the system because of failure to adhere to this procedure will be the sole responsibility of the customer. Contact South-Tek Systems for a return shipping address.
- Shipping charges must be prepaid on all returns.

## 2 SAFETY GUIDELINES

The following section outlines the basic safety considerations regarding installation and operation of the Quick-Check. For additional safety information regarding other equipment used in conjunction with the Quick-Check, such

as air compressors, dryers, boosters, etc., please refer to individual manufacturer recommendations and safety guidelines.

## 2.1 GENERAL SAFETY PRACTICES

Correct use of the Quick-Check-PowerSaver Manifold is important for your personal safety and for trouble-free functioning. Incorrect use can cause damage to the Quick-Check-PowerSaver Manifold or can lead to incorrect gas supply.

The Quick-Check analyzes nitrogen (N<sub>2</sub>) at a low flow rate, which quickly dissipates into the air when exhausted. N<sub>2</sub> gas is not poisonous but the gas should not be directly inhaled since in high concentrations it can cause asphyxiation. Ensure the unit is installed within a well-ventilated room.

Read carefully and act accordingly before installing, operating, or repairing the unit.

- Operator must use safe working practices and rules when operating the Quick-Check.
- The owner is responsible for keeping the unit in safe operating condition at all times.
- Always use approved parts when performing maintenance and repairs. Make sure that replacement parts meet or exceed the original parts' specification.
- Only authorized, trained, and competent individuals are allowed to perform installation, operation, maintenance, and repair.
- Completely isolate incoming and outgoing pressures to the generator, and make sure to depressurize the service/repair section prior to performing any mechanical work, including changing the filters. The nitrogen generator's exhaust gas and/or any venting gas must be vented to the outside or to a large, well-ventilated room to avoid suffocation due to lack of oxygen.
- Safety glasses should be worn if the cabinet door is open while the machine is operating.

**WARNING:** Pressurized gases are contained within the generator, the receiver, and product tanks. Pressurized gases are dangerous and may cause injury or death if handled or used inappropriately.

- Never allow pressurized gas to exhaust from an unsecured hose. An unsecured hose may exhibit a whipping action, which can cause serious injury. If a hose should burst during use, immediately close all isolation valves if it is safe to do so and power down the unit.
- Always make certain that the Quick-Check is disconnected from the supply power prior to performing any electrical work.

## 2.2 SAFETY INFORMATION

Nitrogen is not poisonous but it should not be directly inhaled, since in high concentrations, it can cause asphyxiation. Ensure that the unit is installed within a well-ventilated room, one that is not sealed off from normal living space air changes.



All personnel involved with installation, operations, and maintenance of the Quick-Check-PowerSaver Manifold must follow safe working practices, OSHA, and local health/safety code regulations during the installation, operation, and maintenance of the unit.

Warning:

- This manual must be read in its entirety prior to installing and operating the Quick-Check-PowerSaver Manifold to prevent accidents and damage to the equipment.
- Contact your supplier if you detect a problem that you cannot solve with this manual.
- Only use the PowerSaver Manifold in accordance with its designed purpose.
- Only service-engineers, that are qualified to work on electric and pneumatic equipment, can do the installation, maintenance, and repairs. Unqualified people are not allowed to repair the equipment.
- Do not tamper or experiment with the equipment or exceed the technical specifications

## 3 PRODUCT INSTALLATION

### 3.1 UNPACKING AND PREPARATION

The Quick-Check-PowerSaver Manifold 6 Port will arrive in a cardboard box. Identify and verify that all parts listed on the packing list are present and undamaged. Ensure that all parts to connect to the AutoPurge System (APS) are with the unit. South-Tek Systems (STS) is not responsible for damages that have occurred during the shipping and handling of the N<sub>2</sub>-BLAST. Any visual damages should be immediately documented and reported to the shipping company responsible. Contact STS at (888) 526-6284 to assess the damages only after the shipping company has been notified.

Until Installation:

- Store the Quick-Check in a dry and climate controlled (60-80°F) room.
- Always keep Quick-Check in a safe place / or in box as shipped.
- Do not connect power until manual has been read completely and all connections are made as stated within.
- Keep all pipes and APS lines dry so moisture does not enter Quick-Check upon hookup.
- Never place/stack objects on top of the Quick-Check.

## 3.2 STORAGE INSTRUCTIONS

If the unit is not to be installed until a later date, a safe dry storage location is needed - preferably inside a controlled environment. Place desiccant packets into the electrical cabinet to keep moisture from damaging the electronics. Do not store around moving objects that could fall or damage the unit. If the unit is kept in storage for an extended time (over 1 month), then the Oxygen Fuel Cell/Analyzer (if included) should be removed, sealed off, and stored in a controlled environment.

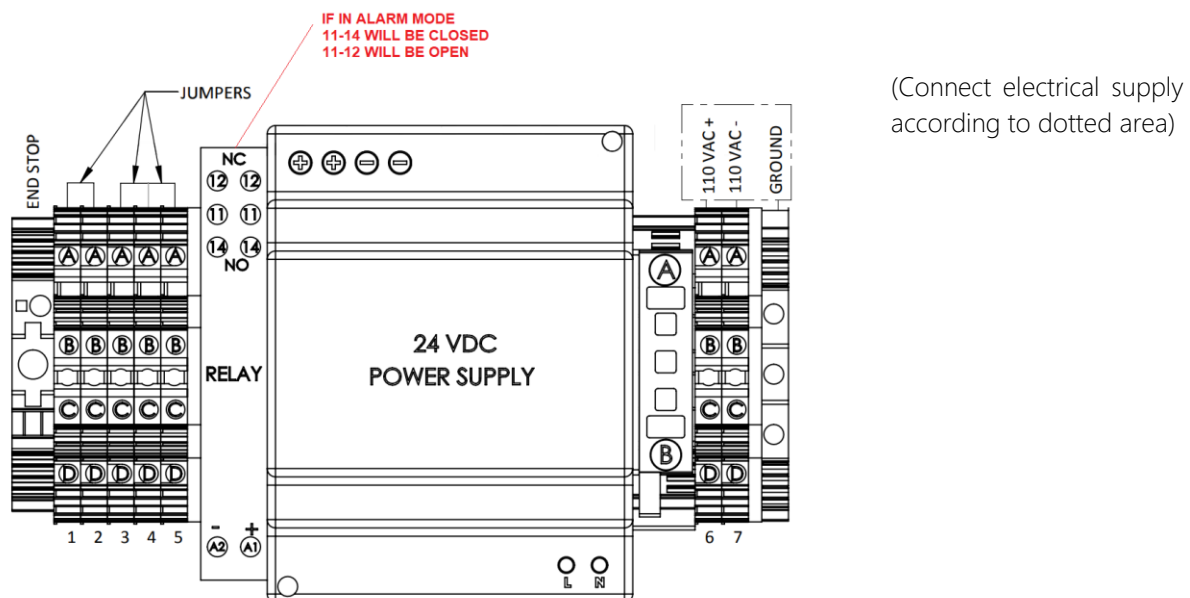

Figure 1: Customer Electrical Connection to Quick-Check PowerSaver Manifold

## 3.3 ELECTRICAL REQUIREMENTS

Power supply must be 110 V or 220 V / 1 ph / 50 - 60 Hz as labeled on the unit. Operating amp draw is less than 2 amps. The Quick-Check must be hardwired unless otherwise specified in the customer installation drawings. The internal control panel is a UL 508A Open Industrial Control Panel approved with a 7 Amp time delay fuse. Electronic copy of the electrical schematic is available upon request.

Note: Always obey all local and site codes to finalize power connection to the equipment.

## 4 SYSTEM DESCRIPTION

### 4.1 KEY FEATURES

The Quick-Check-PowerSaver Manifold and all components are securely packed to minimize possibilities of damages during shipment. The contents of the shipment should be inspected upon delivery to assure that no damage has

taken place during transit. Save the packaging material, as it may be necessary to return the Quick-Check in event of shipping damage. If any components are found to be damaged, the carrier should be notified immediately. The individual pieces should be checked against the packing list. If any discrepancy is found, contact your local distributor or South-Tek Systems at (888) 526-6284. Please include the model number and the serial number with all correspondence.

The Quick-Check-PowerSaver Manifold 6 Port key features include the following:

- Programmable Logic Controller (PLC) with HMI
- Dry Contact Alarm Relay
- Pre-Filter
- O<sub>2</sub> Analyzer
- Gas Input Solenoid Valves on a Manifold
- Exhaust Valve
- 110-220VAC to 24VDC power converter

#### Programmable Logic Controller (PLC) with HMI

The device is setup with a 24 VDC power converter that will accept either 110 or 220 VAC power supply. The PLC has a built in 3.5" color touchscreen with 1MB of logic memory, 3MB for images, and 512K bytes for fonts. It has a logic application scan time of 15 microseconds per 1Kbytes of application code.

#### Dry Contact Alarm Relay

Each Quick-Check-PowerSaver Manifold features a dry contact to send an alarm signal to the Building Management System (BMS). If the purity status goes above the allowable percent of O<sub>2</sub> or if the flow sensor is not receiving a signal on any one zone or more, then the alarm on the unit will trip and engage the Dry Contact Relay.

#### Pre-Filter

The Pre-Filter consists of a filter bowl and particulate filter element with a 5 microns rating that will catch any particles coming from the fire system pipes and protect the O<sub>2</sub> sensor. The filter features an auto-drain that can be plumbed to a safe location. The pre-filter is used to remove harmful contaminants in the gas streams that may reduce the life of the O<sub>2</sub> cell. Based on the quality of gas going through the filter, the filter may be required to be changed out more often than the factory recommended replacement date.

#### O<sub>2</sub> Analyzer

The O<sub>2</sub> Analyzer is used to detect the O<sub>2</sub> content of each Zone. It is a galvanic cell type that implements a weak acid electrolyte and is unaffected by CO<sub>2</sub>, CO, and NOx. It has a response time of 25 seconds or less and will respond to a 90% step change in Oxygen concentration within 15 seconds or better. The output from the O<sub>2</sub> sensor is a 10mV to 15.5mV signal that is sent to the PLC. The signal from the O<sub>2</sub> sensor is digitized on the PLC by a 10-bit analog to digital converter and calibrated to known O<sub>2</sub> calibrated sources.

#### Gas Input Solenoid Valves on a Manifold

The bank of solenoid valves on a manifold is located on the outside bottom of the cabinet. Each Zone's sample (from the "AutoPurge System") will be connected to each solenoid valve. Each valve is

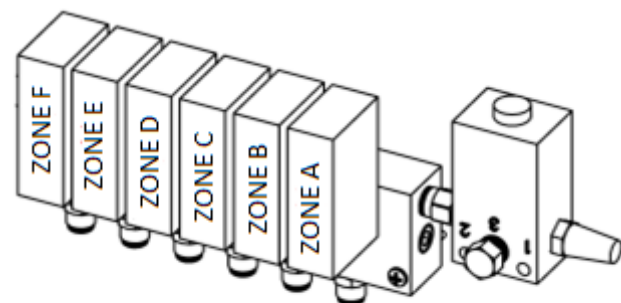

Figure 2: Zone Manifold Layout

independently controlled and operated by the PLC based on the O<sub>2</sub> content of the corresponding Zone. Depending on the Quick-Check series model, procedures for unpacking the equipment(s) may vary.

#### Exhaust Valve

The exhaust valve is at the end of the manifold block. It is there to purge out the Zone to acceptable O<sub>2</sub> levels.

#### 110-220VAC to 24VDC power converter

The device is setup with a 24 VDC power converter that will accept either 110 or 220 VAC power supply.

## 4.2 SPECIFICATIONS

| Quick-Check-PowerSaver Manifold 6 Port– Specifications |  |
|--|--|
| Installation   | Wall Mount   |
| Display  | Zone Purity Status, Alarm Status, Zones, System Status, Power Status |
| Manifold Port Connections                              | ¼" PTC straight fittings   |
| Electrical   | 110-220V / 50-60Hz / 1Phase; <2amp                                   |
| Ambient Temperature                                    | 40° to 90°F  |
| Size   | 12.07" W x 7" D x 13.5" H (Cabinet Dimensions)                       |
| Weight   | ~24lbs   |

## 5 SYSTEM CONTROLS AND COMMUNICATIONS

The Quick-Check-PowerSaver Manifold comes with controls and instruments uniquely programmed (proprietary to South-Tek) with a control sequence to effectively and efficiently analyze nitrogen in Fire Protection Systems. Unauthorized changes to the system will void all warranties and may cause damages to the system or cause it to malfunction.

This section describes the function of the major controls and instrumentation associated with the Quick-Check. Do not attempt to alter any controls or instrumentations; any changes without South-Tek Systems' consent will void the performance specifications unique to the system.

The PLC is used for the control sequence of the valves and controls the Quick-Check's functionality. All programs are proprietary and password protected from the factory.

Note: Controls for supporting equipment, such as the compressor, dryer, and/or nitrogen generator, are not included in this section. Please consult the original manufacturer's instructions for further information.

## 5.1 HOME SCREEN

The home screen displays relevant information regarding the Quick-Check and Zones such as system status, purity status of each zone, current mode, and run hours. The user can manually start/stop and navigate to either the "Menu", "Zone Setup" by pressing the "Legend" button or "Zone Info" by pressing the "Purity". The Zone Setup will show which letter corresponds to each zone while the Zone Info will show the last purity readings of each zone.

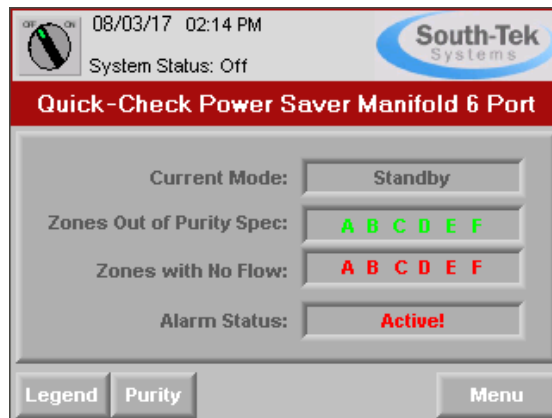

Figure 3: Home Screen

## 5.2 POWERING ON/OFF

Powering On/Off all power to the unit can be done with an external power switch or disconnect, typically supplied by others.

## 5.3 HMI INPUT FUNCTIONS

The built-in touch screen allows the user to input different variables / conditions to the device. The user will have access to multiple screens that will allow them to change or view current settings, alarm ranges, and reset alarms. Most screens have options for bringing the display back to the Main screen with a "Home" button. Some screens will also display "Menu" which will return the user to the Menu screen keypad entry will appear when touching an adjustable variable box. The keypad entry can be seen in the figure below.

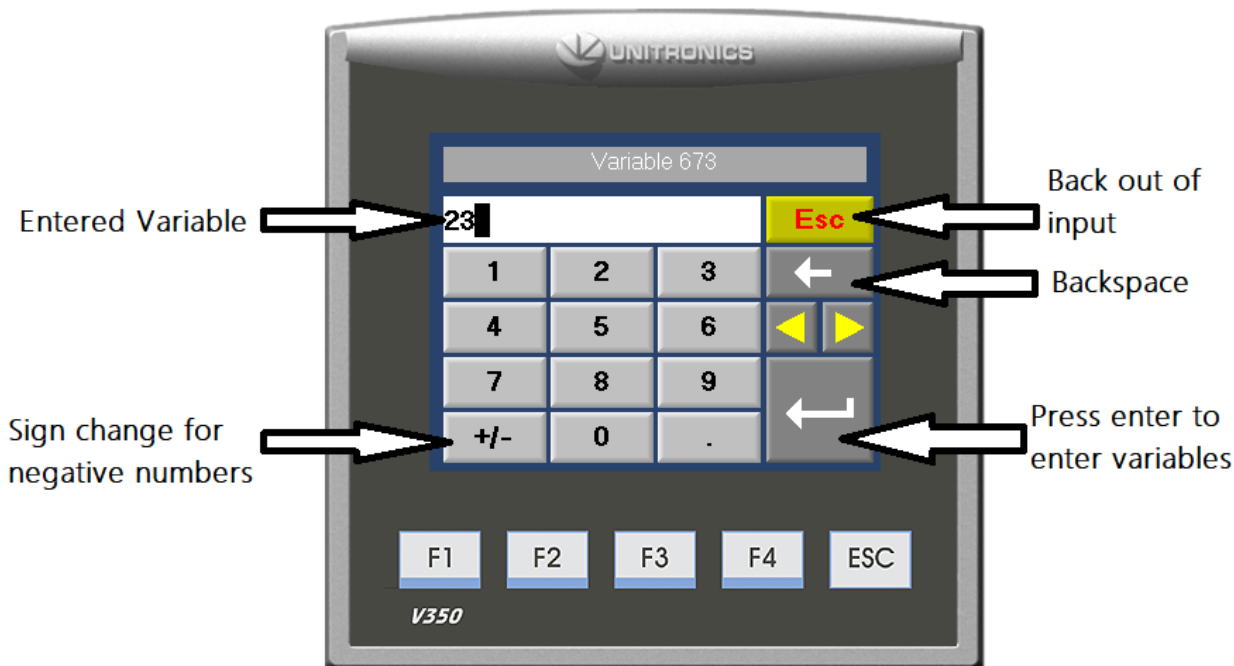

Figure 4: HMI Input Screen

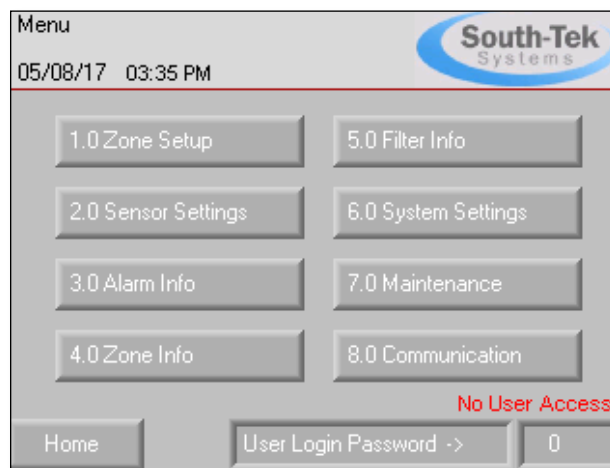

Figure 5: Main Menu Screen

### 5.4 MENU SCREEN

The "Main Menu" screen (accessed from home screen), is password protected. Please consult the second page under "Revision History" of the provided hard-copy manual for the user password.

Once access is granted to the “Main Menu”, the user can access all but the “System Settings” options shown in figure to the right.

### 5.5 SENSOR SETUP/CALIBRATION

The “Sensor Settings” screen allows the user to calibrate sensors included with the Quick-Check.

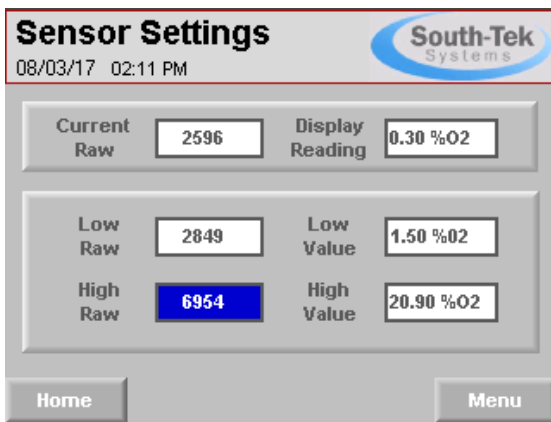

|      | Calibration Value Ranges |            |
|------|--------------------------|------------|
|      | Low Value                | High Value |
| O2 % | 0.5-1.5% O2              | 10-21% O2  |

Figure 6: 2-Pt Purity Calibration

Table 1: Recommended 2-Point Calibration Ranges

All sensors are setup with a 2-point linear calibration. To setup the calibration, the user will need two known points. It is best to select two points at opposite ends of the sensor’s calibration range. The chart above is the recommended 2-Point Calibration range for the “Low Value” and “High Value”.

The “Low Raw” and “High Raw” are determined by the “Current Raw” reading at the time the known calibration source is applied to the sensors. For example, when the known purity is 20.9% O2 to the Oxygen Sensor, read the “Current Raw” value and enter that in the box next to the “High Raw” text. Then apply a known purity of 1.5% O2 to the sensor and read the “Current Raw” value (which should be different – if not, the sensor or wiring connection may be bad) and enter that value in the box next to the “Low Raw” text once the reading becomes pretty steady (apply the gas for at least 2 minutes).

Other notes for calibrating units with % O2 sensors:

1. Make sure certified gas is being used for the low point.

2. Clean dry compressed air (20.9% O<sub>2</sub>) can be used for the high point.
3. Make sure to only flow 1-2 scfh to the sensor. Higher flow may damage the sensor.
4. Never block the outlet purge line

## 5.6 ALARMS/FILTER PARAMETERS

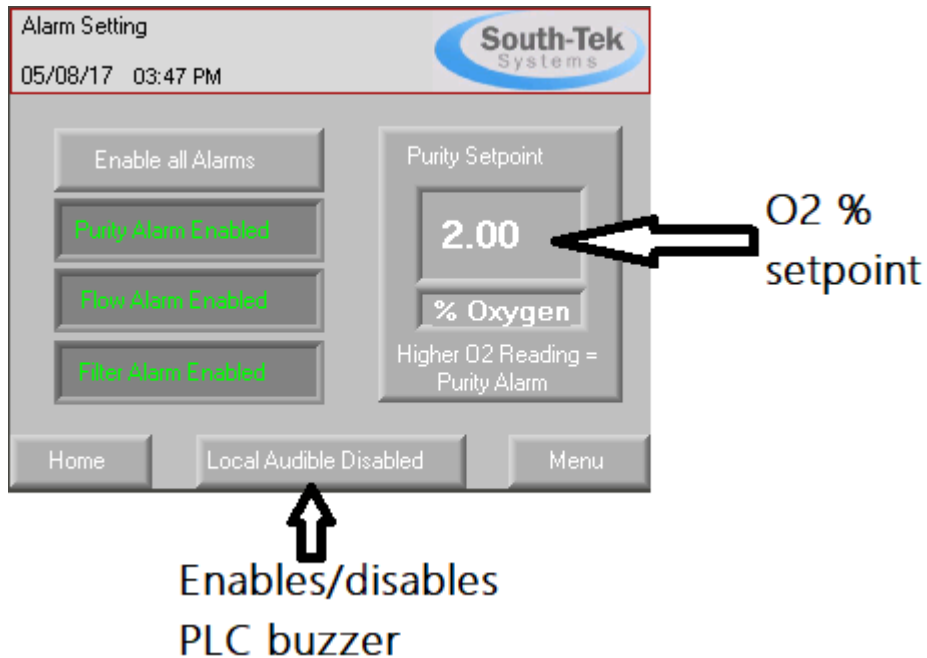

Figure 7: Alarm Settings Screen

The "Alarm Info" menu displays the O<sub>2</sub> alarm setpoint on the right with the purity alarm, flow alarm, and filter alarm enable/disable buttons on the left. Local audible alarm can be enabled/disabled to produce an audible beep in the Quick-Check when enabled alarms are triggered.

**Purity Alarm:** The box under the "Purity Setpoint" is the user alarm setpoint. Factory default setpoint is 2.00% O<sub>2</sub>. The "Purity Alarm" is triggered when any zone's O<sub>2</sub> purity reading is higher than the setpoint value.

**Flow Alarm:** The Flow Alarm is triggered when there is either too little or no flow coming from any or all zones.

**Filter Alarm:** The "Filter Alarm" is triggered when the "Date of Next Filter Change" is reached on the "Filter Info" screen.

These alarms can be disabled by toggling the "Enable/Disable" button on the "Alarm Settings" screen. The local audible can be "Enabled/Disabled" on the "Alarm Settings" screen as well.



Active Alarms/Reset Alarm Status:

When an alarm status is read in the system, the unit will display the alarm status on the "Alarm Info" screen. Alarms can be reset by typing the reset code into the Reset Alarm block and pressing "Reset Alarm". **Before resetting the Filter Alarm, read the "Filter Info" section.**

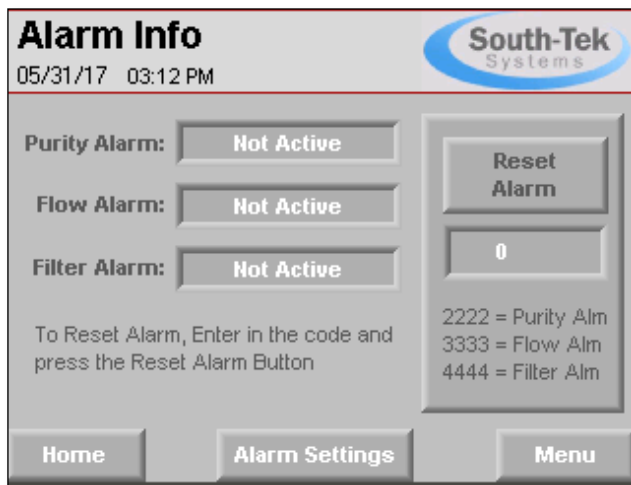

Figure 8: Alarm Status Screen

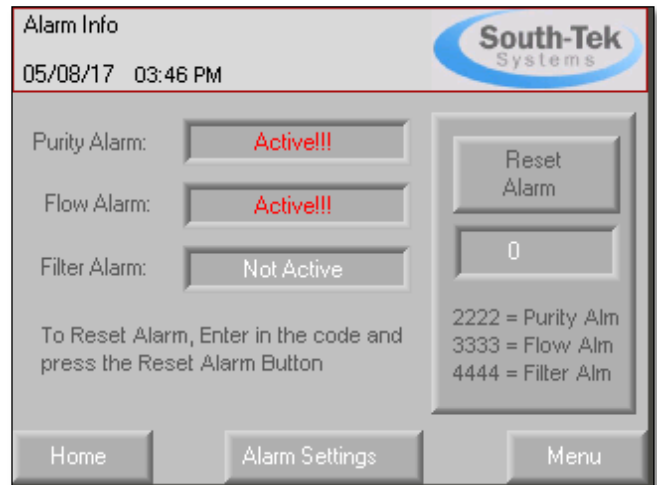

Figure 9: Alarm Status Active

Filter Info:

The "Filter Info" screen will display the current filter status of either "Good" or "Filter Change Required!". If "Filter Change Required!" is highlighted, it is advisable to change out the pre-filter. **To reset the filter replacement date after changing the filter, please see previous section.**

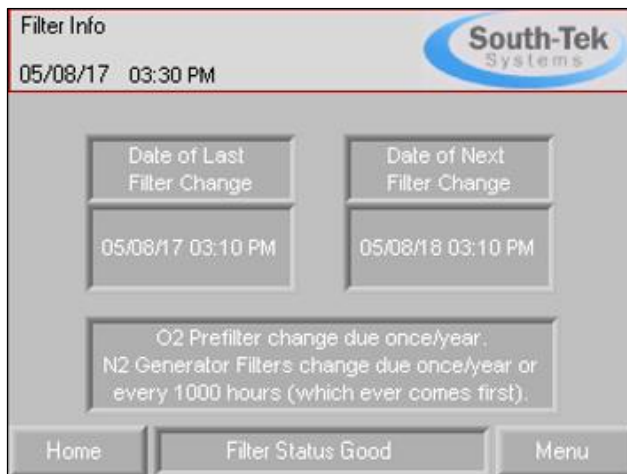
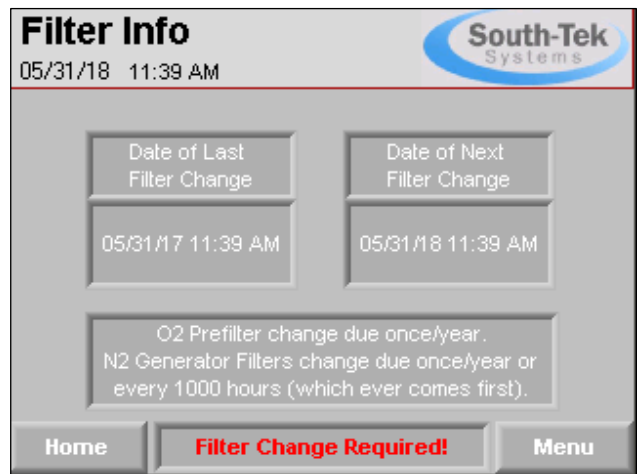

Figure 10: Filter Info Screen



### 5.7 ZONE HISTORY

To access the "Zone History" screen, open the "Zone Info" screen in the "Menu" and press the "Zone History" button at the bottom of the screen. Zone History can be reset by entering the code "7777" into the box next to "Reset Days" button and then press the button.

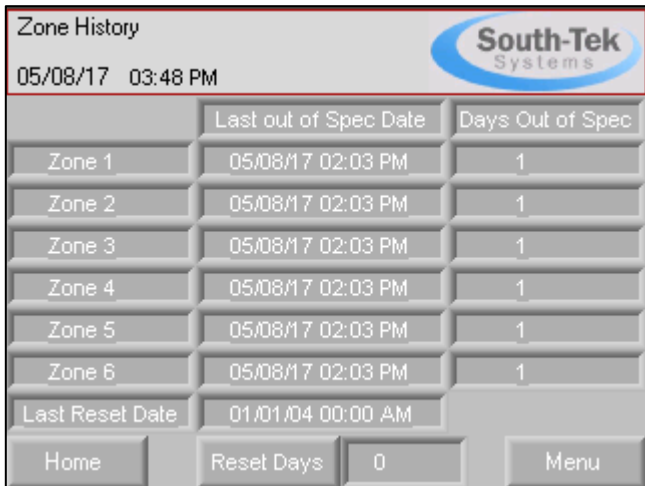

Figure 11: Zone History

### 5.8 COMMUNICATION SETTINGS FOR ETHERNET CONNECTION (OPTIONAL)

Ethernet communication is an optional feature that can be purchased with each Quick-Check-PowerSaver Manifold. Once it is included, the user can communicate with the system by assigning a static IP address to the controller and entering in that IP address into the controller. Once the static IP is entered, the user must press the connect button or cycle the power to the controller to see the device on their intranet network. Communication through Ethernet includes Remote Access, SD Card Access, and MODBUS TCP/IP communication. A connection status message will indicate if a successful connection has been made.

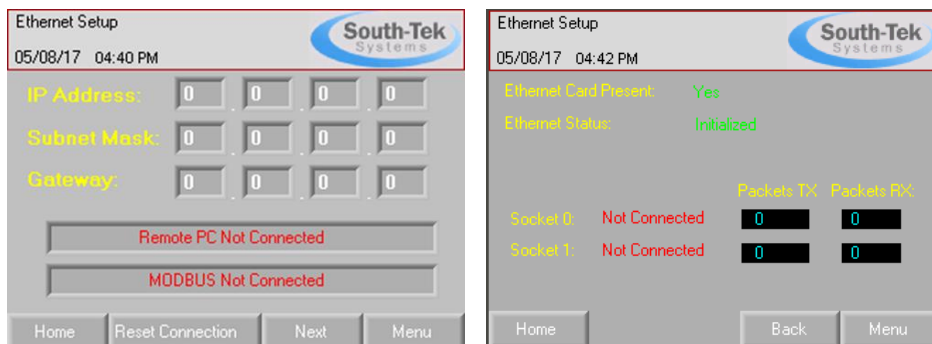

Figure 12: Network Connection Screens

#### Remote Access

A copy of the setup files for this software will be included on the microSD card installed in the PLC if the Ethernet option was purchased. This software can be installed on any windows based PC with Windows 7 or higher. The user will have full access of the controller touchscreen as if the user was standing in front of the machine and using the mouse to navigate through the screens. To set up communication connection to the controller, the communication settings on the computer must be set up as the following:

1. Open the Remote Access Software and go to the "Configurations >Communication - PC settings".

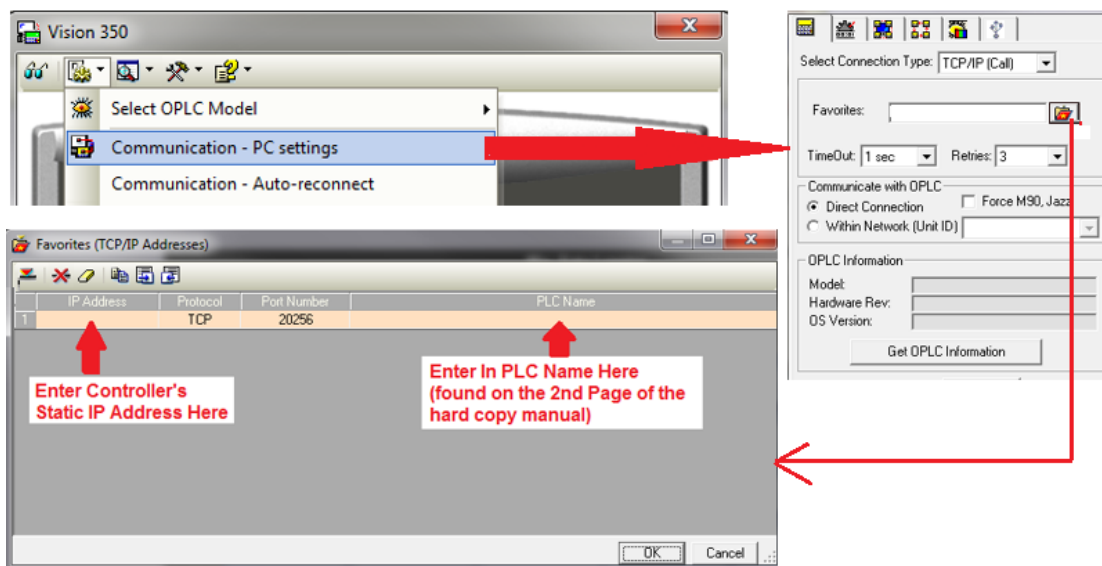

Figure 13: Remote Access Communication Setup

2. Select Connection Type: TCP/IP (Call)
3. Press the red folder to bring up the TCP/IP Addresses setup.
4. Enter in the static IP address assigned to the controller under "IP Address" column.
5. Select "TCP" under "Protocol" column.
6. Enter in the PLC Name (found on the 2<sup>nd</sup> page of the hard copy manual included with the Quick-Check).
7. Press the "Get OPLC Information" to make sure the connection information is correct. An error message will appear if the information is incorrect.
8. Press "Exit" once the connection information has been confirmed.

Loading Image File and Logging on

1. Open the Remote Access Software and go to the "Configurations > Select Fonts and Images file (\*.urc)".
2. Browse for the file "PLC Image File.urc" which is loaded onto the SD card.
3. Press the "Glasses" icon in the left corner of the software to establish real time connection with the controller.

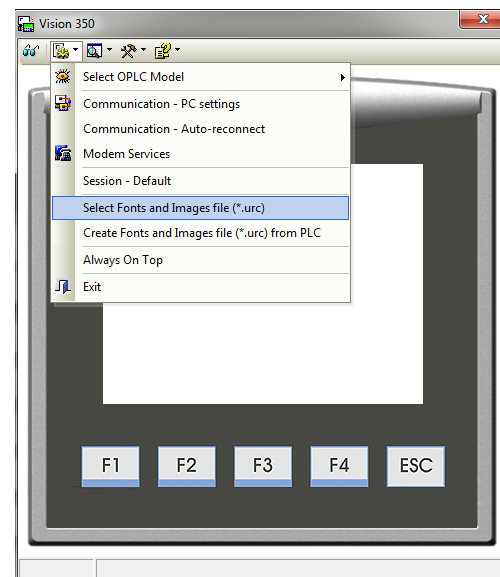

Figure 14: Loading Image

SD Card Access

The setup SD Card Access file will also be included on the microSD card installed in the PLC. The SD Card Explorer software can be installed on any windows based PC with Windows 7 or higher. This allows the user to have access of the files on the SD card without having to physically remove the SD card. Set up the communication similar to how the Remote Access is set up.

**MODBUS Communication**

Once the Quick-Check is provided with a static IP addressed and can be seen on the network, MODBUS communication can be set up to retrieve real time data. The Quick-Check MODBUS Communication settings are as follows:

- Protocol: TCP
- Local Port: 502
- PLC Controller: Slave

See MODBUS addressing table below:

**Table 2: MODBUS Addressing Table**

|                                | STS Controller (Unitronics) | SCADA | Units      | Read/Write |
|--------------------------------|-----------------------------|-------|------------|------------|
| Last Zone 1 O2% Purity         | MI 21                       | 40022 | XXX.XX% O2 | R          |
| Last Zone 2 O2% Purity         | MI 22                       | 40023 | XXX.XX% O2 | R          |
| Last Zone 3 O2% Purity         | MI 23                       | 40024 | XXX.XX% O2 | R          |
| Last Zone 4 O2% Purity         | MI 24                       | 40025 | XXX.XX% O2 | R          |
| Last Zone 5 O2% Purity         | MI 25                       | 40026 | XXX.XX% O2 | R          |
| Last Zone 6 O2% Purity         | MI 26                       | 40027 | XXX.XX% O2 | R          |
|                                |                             |       |            |            |
| N2 Alarm Setpoint              | MI 6                        | 40007 | XXX.XX% O2 | R/W        |
| Start / Stop                   | MB 0                        | 00001 |            | R/W        |
| Alarm 1 (Overall Zone Purity)  | MB 94                       | 00095 |            | R          |
| Alarm 2 (Flow Alarm)           | MB 95                       | 00096 |            | R          |
| Alarm 3 (Filter Change Status) | MB 96                       | 00097 |            | R          |

| Coils              |              | MODBUS Command Number |                 |
|--------------------|--------------|-----------------------|-----------------|
| Pointer Value From | Operand Type | Read                  | Write           |
| 0000               | MB           | #01 Read Coils        | #15 Force Coils |

| Registers          |              | MODBUS Command Number |                              |
|--------------------|--------------|-----------------------|------------------------------|
| Pointer Value From | Operand Type | Read                  | Write                        |
| 0000               | MI (16 Bit)  | #03 Read Coils        | #16 Preset Holding Registers |

**6 READING THE QUICK-CHECK ZONE STATUS**

**6.1 ZONE PURITY STATUS**

The purity status of each of the zones can be determined by the color of the zone letters in the "Zones out of Purity Spec:" row on the Home screen show in Fi.

Red = Zone not within purity setpoint of the system

Revision: 0

Revision Date: 8/2/17

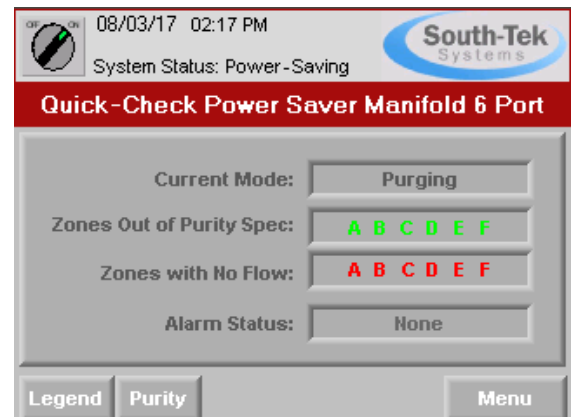

Green = Zone within tolerable purity limits

### 6.2 ZONE FLOW STATUS

The flow status of each zone is indicated in the "Zones with No Flow:" row. Zones with too little or no flow from the APS will show up as a red letter, whereas zones with sufficient flow will be green.

Figure 15: Home Screen

### 6.3 CURRENT MODE

The current mode will display one of two things:

- Purging – Purging occurs during initial start-up and in-between sampling of zones.
- Zone sampling – Displays which zone is being currently sampled

### 6.4 ALARM STATUS

The alarm status is determined by alarms being triggered. If an alarm has been triggered, the alarm status will read "Active". The type of alarm can be viewed by accessing the "Alarm Info" screen in the "Menu".

### 6.5 ZONE SETUP

The Quick-Check starts sampling the zones one by one at the same time every day starting with "Zone A". To change this time, access "Zone Setup" within the "Menu" screen and press "Sampling Settings". On the left side of the screen under the "Time of Day for Sample", input the desired time for the zones to be read each day it is set to sample. (Factory default is set to sample each zone daily for "x" minutes, and to purge any zones which are out of spec for 24 hours.)

The duration of purge after the sample and sample frequency may also be changed on this screen. (Factory default is set to sample every day and to purge for 24 hours)

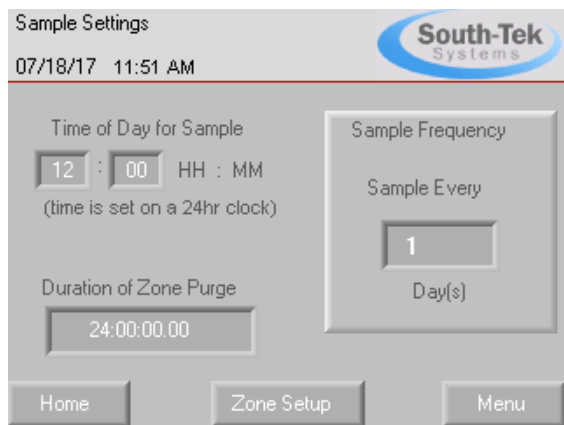

Figure 16: Sample Settings

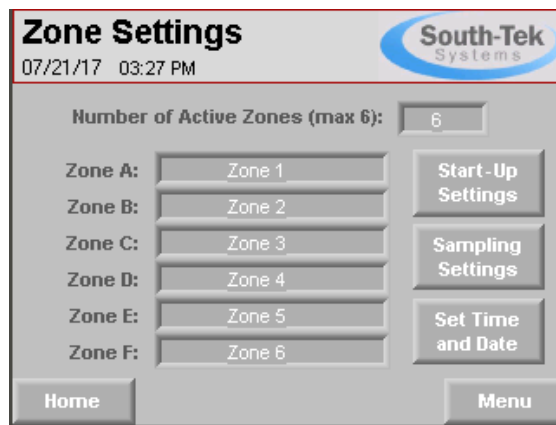

Figure 17: Zone Setup Screen

## 7 QUICK-CHECK-POWERSAVER MANIFOLD OPERATIONS AND START-UP

This section describes procedures to start, run, and stop the Quick-Check-PowerSaver Manifold. The operator should notify personnel in the area of the equipment start-up. Make sure the start-up will not interfere with other operations.

### 7.1 START-UP

This section describes the necessary steps of both the initial start-up and a normal routine start-up. If this is the first time the unit has been started, follow the Initial Start-up procedure.

#### 7.1.1 Initial Start-Up

1. Mount device in a ventilated, non-hazardous location. The cabinet has four screw holes at the corners that can be used to safely mount the box.
2. Verify that power connection is 110 V or 220 V / 1 PH / 50 - 60 Hz as labeled on the unit and that the touchscreen on the PowerSaver is in the "OFF" mode (the "ON/OFF" selector switch in the upper left corner of the "Home" screen).
3. Close all valves and flow controls on the AutoPurge System (APS) which will connect to the Quick-Check. Ensure that there is no water that will make it into the APS when the Fire Protection System is pressurized and then fill the system with nitrogen. Fix any leaks found in the FPS and, once all leaks have been corrected, set up each APS according to the APS tuning instruction sheet in Section 9 - AutoPurge system tuning.
4. Once the Quick-Check-PowerSaver Manifold is securely mounted, run the ¼" OD poly tubing from each APS to the corresponding monitored Zones. The max number of Zones that one device can monitor properly is 6. Connect each corresponding Zone to the manifold with the far left being Zone F and the far right being Zone A.
5. "Initial System Purge" can be utilized to allow the system to get down to the purity setpoint without alarming.

**NOTE:** During the start-up sequence, check for leaks in all pipe-fittings and tubing.

**WARNING:** Shut off air supply valve and depressurize the system before repairing any leaks.

6. Set date and time to the current date and time in the area by navigating to the "Date and Time Screen" seen in **Figure 18**. To open this screen press the "Zone Setup" button in the menu, then press the "Set Time and Date" button seen in **Figure 17**.

Press the "Get Current" button to display the current date and time in the input box. Press the input box above the "Get Current" button and type in the desired date and time then press enter.

Once you press the "Set Date & Time" button the current time and date will be set to parameters displayed in the input box.

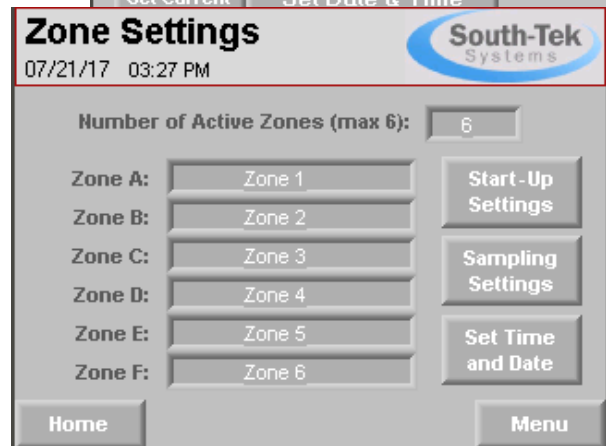
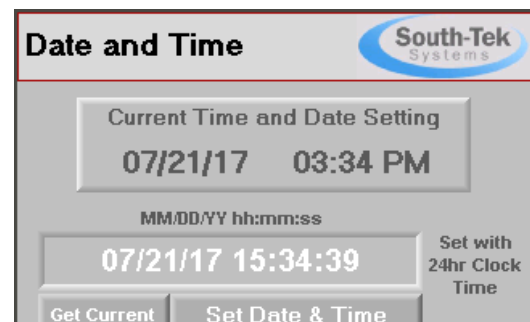

7. Change the "Number of Active Zones" in "Zone Setup" which can be accessed through the "Menu" or the "Legend" button. Press inside the box to change the number to the number of zones that will be required for the system. This screen can be seen in **Figure 19**.
8. (Optional) Change the name of the zones in "Zone Setup" which can be accessed through the "Menu". The user can press any zone to change each to a more descriptive name of up to 8 characters.

**Figure 19: Zone Setup Screen**

### 7.1.2 Initial System Purge

When a Fire Protection System is first filled with nitrogen, it mixes with the atmospheric air already within the pipes and fittings. In order to get the pipes down to an acceptable purity level, the AutoPurge System should be used. The Quick-Check's PowerSaver Manifold will vent out a small amount of gas to eventually lower the oxygen purity to an acceptable level. To account for the amount of time it will take for the system to get within the parameters of the setpoint, the user can engage the Initial System Purge which will allow a default of 40 days of purging without alarm.

To set up the Initial System Purge, open the "Zone Setup" screen found in the "Menu", then press "Start-Up Settings" and the screen in **Figure 20** figure below will be displayed. The user must turn the Initial System Purge on with the selector switch to the right of the "Initial System Purge (Days)" to start it. Before conducting this step, the Initial System Purge(Days) can be set by the user by pressing in the box next to it (factory default is set to 40 days).

This feature will automatically turn off once the "Days left in Initial System Purge" reaches 0, but it may be turned off manually at any point by pressing the toggle switch again.

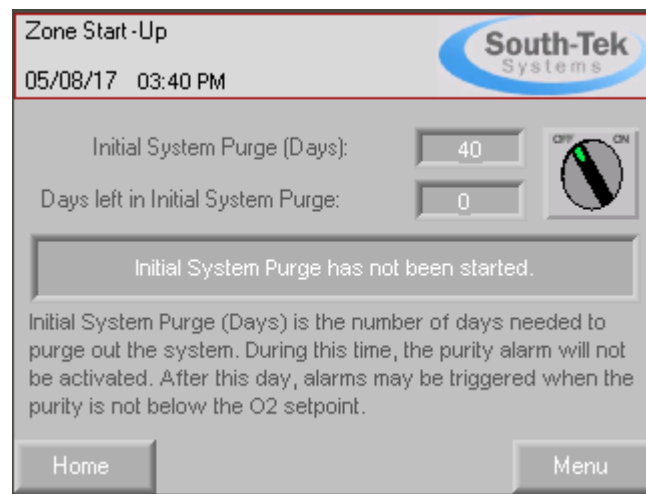

**Figure 20: Initial System Purge**

### 7.1.3 Normal Start-up

Follow this procedure to start the Quick-Check for normal operation. If this is the first time the unit has been started, follow the Initial Start-Up procedure above, otherwise:

1. Open all APS zone ball valves and ensure all APS flow tuning is correct according to the APS Tuning Sheet.
2. Toggle the "ON/OFF" button on the "Home" screen to the "ON" position to start the system

**NOTE:** If the generator or any part of the system has been opened to the atmosphere or water, the system must be purged of any residual air/water to get within the limits of the purity setpoint. Another "Initial System Purge" is advised.

## 7.2 SHUTDOWN

For normal shutdown, toggle the "ON/OFF" button to OFF on the "Home" screen.

**WARNING:** The Quick-Check-PowerSaver Manifold will remain pressurized after shutdown. Before performing any maintenance or opening any piping systems, always depressurize the system. Failure to do so may result in injuries.

# 8 SYSTEM MAINTENANCE

## 8.1 FILTER ELEMENT REPLACEMENT

All units come equipped with a pre-analyzer filter. Clean filter elements are important for good system performance. Factory recommendation on filter change out schedule are as follows:

-Pre-analyzer filter: 12 months (Once per year)

See instructions below for how to remove/replace the filter element.

**WARNING:** Do not try to remove filter bowls until the filter is completely depressurized. Valve off the incoming gas supply by turning the selector switch on the main screen to the OFF position.

1. Disconnect the tubes from the bottom of the bowls (if tied into condensate drain system).
2. To remove the bowl, turn the metal casing around the clear blue plastic bowl counter-clockwise until it unscrews completely from the housing. Then twist slightly and pull the blue plastic bowl downwards out of the housing.
3. Inspect the bowls. If the drain system is working properly, the bowls should not be full of water.
4. Remove the filter element by carefully pulling the black plastic filter element holder out of the filter bowl and twisting the top and bottom piece counter-clockwise until the holder pulls apart. Take notice of how the element looks. If the element is excessively dirty, more frequent filter changes are recommended.

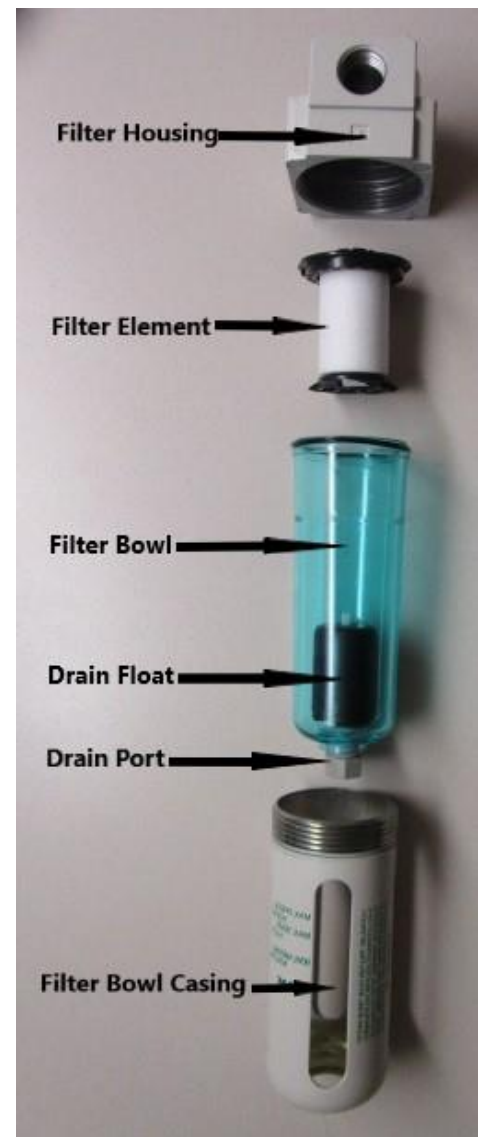

Revision: 0

Revision Date: 8/2/17

Figure 21: Filter Replacement



**NOTE:** A plugged drain system will cause water and oil to carry over into the system, which will cause permanent damage to the media inside the Quick-Check PowerSaver 6 Port Manifold. Such damage is not covered by the manufacturer's warranty. Use of filters other than those specified by South-Tek Systems could result in damages not covered by the warranty.

*Figure 27:*

5. Wash the bowls in soapy water and rinse thoroughly as needed. Use of light air gun to remove debris is also acceptable. Make sure to always wipe down with a clean and dry cloth.
6. Install new filter element and replace O-rings as needed.
7. Put the filter bowl back on the system in reverse order of how it was removed making sure the bowl is seated in place correctly. Only tighten metal casing around filter bowl hand tight.

## 8.2 MAINTENANCE SCREEN

### 8.2.1 Maintenance Test

Maintenance Test is a feature on the Quick-Check-PowerSaver Manifold 6 Port which allows the user to view a quick operation of the sampling function in the unit. To utilize the Maintenance Test ensure the ON/OFF selector switch on the Home screen is in the ON position then navigate to the Maintenance screen through the main Menu page.

The Maintenance Test can be started by pressing the button on the right, it will cycle through each of the zones for twenty seconds each. Once the last zone is sampled, the unit will return to normal operation.

**Note:** Do not turn off the Maintenance Test once it has started, if the test needs to be stopped at any point press the selector switch on the Home screen to the OFF position

This test mode will take purity and flow readings on each zone although normal run purity may differ from this reading.

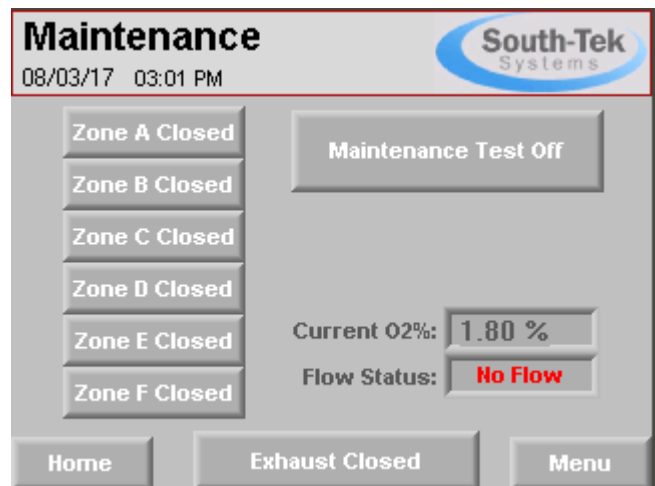

Figure 22: Maintenance Screen

### 8.2.2 Valve Test Mode

Valve Test Mode is a feature on the Quick-Check-PowerSaver Manifold 6 Port which allows the user to actuate each individual solenoid valve to ensure proper function. To utilize the Valve Test Mode turn the ON/OFF selector switch on the Home screen to the OFF position then navigate to the Maintenance screen through the main Menu page.

The Valve Test Mode can be enabled or disabled by toggling the button on the right. Once enabled, each valve on the page may be actuated by pressing the corresponding button. This mode can be used specifically for troubleshooting purposes or pressure testing.

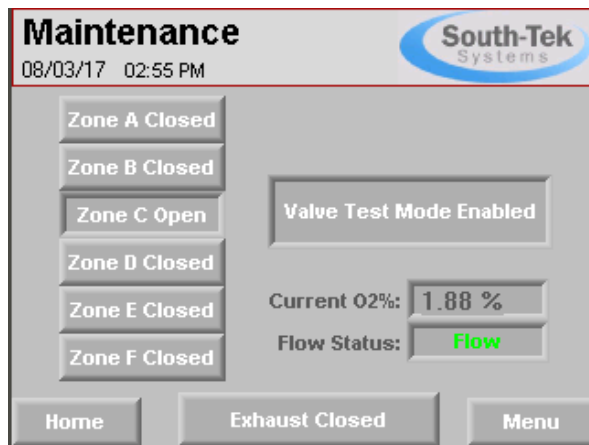

Figure 23: Valve Test Mode

## 9 AUTOPURGE SYSTEM TUNING

1. Close each APS ball valve. Make sure each flow control (Figure 26) is turned all the way clockwise.
2. Bring the Fire Protection System up to Supervisory Pressure.
3. Mark each 1/4" APS purge line from all zones so that they can easily be matched to the appropriate zone number on the Quick-Check PowerSaver Manifold, then remove all of the 1/4" purge lines from the Quick-Check PowerSaver Manifold.

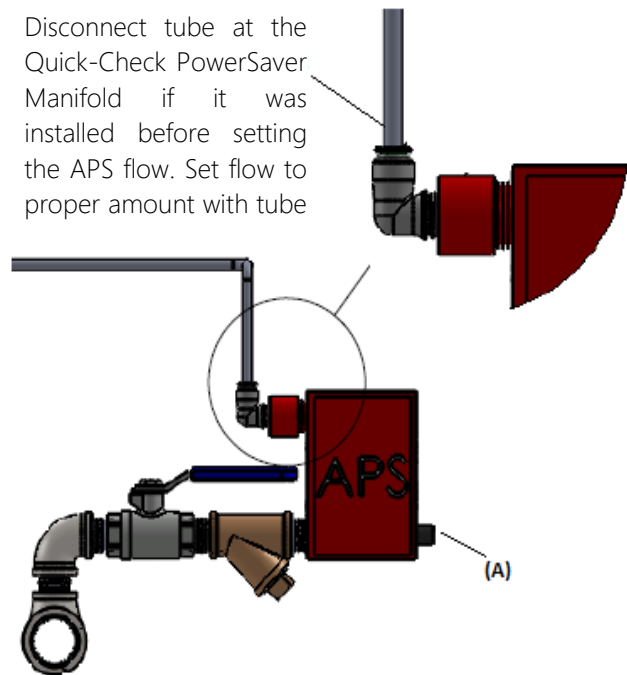

Figure 24: APS Field Installation

4. Slowly open the ball valve on each APS, then turn the APS flow control (Figure 24) counter-clockwise until the center of the float bead reaches setting D.

- Once the float bead has stabilized, the 1/4" tubing may be re-connected to the appropriate zone port on the Quick-Check PowerSaver Manifold.

| Gallons in Zone   |       | APS 2 Flow Setting |       |
|---|-------|--------------------|-------|
| Set the APS Flow Setting once the FPS system is at supervisory pressure. Use the bleed screw below to relieve the water check feature if no flow occurs, see manual for instructions.   |       |                    |       |
| 50  | 1/4   | 600                | C     |
| 100   | 1/2   | 650                | C+1/4 |
| 150   | 3/4   | 750                | C+1/2 |
| 200   | A     | 800                | C+3/4 |
| 250   | A+1/2 | 850                | D     |
| 300   | A+3/4 | 900                | D+1/4 |
| 350   | B     | 950                | D+1/2 |
| 400   | B+1/4 | 1000               | D+3/4 |
| 500   | B+1/2 | 1050               | E     |
| 550   | B+3/4 |                    |       |
| Warning: AutoPurge Systems should be valved off during all FPS pressure tests. This system allows a controlled purge of the FPS system and should be set to the proper APS Flow Setting only. Other settings may cause the FPS to alarm or malfunction. |       |                    |       |
| www.southteksystems.com   |       |                    |       |

| Gallons in Zone   |       | APS 4 Flow Setting |       |
|---|-------|--------------------|-------|
| Set the APS Flow Setting once the FPS system is at supervisory pressure. Use the bleed screw below to relieve the water check feature if no flow occurs, see manual for instructions.   |       |                    |       |
| 1100-1200   | A     | 2600-2750          | B+3/4 |
| 1250-1500   | A+1/4 | 2800-3050          | C     |
| 1550-1700   | A+1/2 | 3100-3300          | C+1/4 |
| 1750-1900   | A+3/4 | 3350-3600          | C+1/2 |
| 1950-2050   | B     | 3650-3850          | C+3/4 |
| 2100-2300   | B+1/4 | 3900-4000          | D     |
| 2350-2550   | B+1/2 |                    |       |
| Warning: AutoPurge Systems should be valved off during all FPS pressure tests. This system allows a controlled purge of the FPS system and should be set to the proper APS Flow Setting only. Other settings may cause the FPS to alarm or malfunction. |       |                    |       |
| www.southteksystems.com   |       |                    |       |



## 10 FAQs

This section enables the operator to determine the cause of operation problems and suggests remedies for the problems. If there are several likely causes, investigate the simpler solutions first. If further assistance is required, contact your local distributor or South-Tek Systems.

| Symptoms               | Probable Cause                       | Corrective Action                |
|------------------------|--------------------------------------|----------------------------------|
| System Not Powering On | Too Low or Too High Voltage/Amperage | Check Electrical Source          |
|                        | Circuit breaker tripped              | Reset circuit breaker            |
|                        | Fuse Blown                           | Replace fuse on electrical panel |

Figure 25: APS 2 Settings

Figure 27: APS 4 Settings

Figure 26: Alphabetical

|                       |   |   |
|-----------------------|---|---|
|                       | System is OFF (Selector switch on Home screen is in the OFF position) | Touch the switch to turn it to the ON position  |
|                       | Defective Wiring  | Check all wired connections                     |
| Purity Status Remains | Too little or no flow to Quick-Check                                  | Check APS flow settings and ball valve position |
|                       | Leak within system  | Check for leaks                                 |

|                              |  |   |
|------------------------------|--|---|
| Red/Alarming                 | Exhaust port plugged   | Check that exhaust tube is not blocked          |
|                              | O2 analyzer malfunction  | Replace O2 analyzer                             |
|                              |  |   |
| Flow Status Remains Alarming | Too little or no flow to Quick-Check                                     | Check APS flow settings and ball valve position |
|                              | Valves, lines, or clear flow indicator before the analyzer is blocked up | Check if system is blocked up                   |
|                              | Lines are not connected/broken coming from the AutoPurge System          | Replace or reconnect lines                      |
|                              | Valves are not actuating   | Check solenoid valve wires/replace valves       |

## 11 KEY CONTACTS

For any questions with the performance and/or maintenance of the system, contact:

South-Tek Systems

2940 Orville Wright Way, Wilmington, NC 28409

Phone: 1-(888)-526-6284, Ext. 127

Email: [info@southteksystems.com](mailto:info@southteksystems.com) or [service@southteksystems.com](mailto:service@southteksystems.com)

Visit: [www.southteksystems.com](http://www.southteksystems.com)

## APPENDIX A: WARRANTY

The Quick-Check-PowerSaver Manifold is warrantied against any defects in workmanship and materials for 12 months from the date of shipment from South-Tek Systems. The purchaser has the liability to ensure that the system is fully inspected upon delivery and shall contact the appropriate shipping company to make any claims on damaged goods due to transit within that shipping company's policies. If the system is received with defects that are not due to shipping, a written claim should be submitted to South-Tek Systems within 1 week of receiving the shipment. South-Tek Systems can deny all other claims at their discretion.

All warranty work shall be done at a South-Tek System facility or at a PSA Nitrogen Generator Authorized Service Center. Only factory trained and authorized personnel are covered under warranty. Any part that is returned / repaired / replaced under warranty may be remanufactured or changed to a different specification at the factory's option. Any work performed by an unauthorized person/company or usage of non-factory parts, may void all warranties to the product.

Any item not manufactured by South-Tek may carry its own warranty from its manufacturer and will be warrantied under that manufacturer. All parts that need to be returned should be announced. Any item(s) that is returned to South-Tek Systems without an RMA number (return authorization number) may be denied and returned to the sender. Contact the factory for RMA #'s, prior to returning shipment.

South-Tek Systems is not liable for damages caused by normal wear and tear, water, fire, erosion, corrosion, explosion, misuse, oil/gas vapors or unauthorized modifications. South-Tek Systems is also not liable for any losses, damages, or cost of delays, including incidental or consequential damages. There are no warranties or guarantees, expressed or implied, including the warranties of merchantability or fitness for a particular purpose or use, other than those warranties expressed herein.

For Claims, contact South-Tek Systems LLC at:

Phone: (888) 526-6284

Email: [support@southteksystems.com](mailto:support@southteksystems.com)

Or write to:

South-Tek Systems, Warranty Claims, 2940 Orville Wright Way, Wilmington, NC, 28409

-----Last Page-----