

LABTEK™

TYP7P Series
70L / 70T / 90D

Operation, Installation
and Maintenance
Manual

Version 01; 07/07/2021
© 2021



The Leader in Nitrogen Generation

VERSION HISTORY

Revision #	Revised By	Revision Date	Approved By	Approval Date	Reason
00	S. Andrews	9/18/20	M. Thomas	12/30/20	Initial Release
01	M. Grant	5/26/2021	S. Andrews	07/07/2021	Update for 1PH electrical

User Passcode:

6557

PLC Name (for Ethernet Communications):

LAB

Electrical Schematic Drawing #:

ES-LAB-003

Other Documentation(s):

Applies to 1PH electrical, SNs:

70T004283 on

70L004283 on

90D004283 on

TABLE OF CONTENTS

Table of contents4

1 INTRODUCTION7

 1.1 Purpose7

 1.2 About South-Tek Systems7

 1.3 Audience7

 1.4 Limits of Liability8

 1.5 Service Return Policy8

2 SAFETY GUIDELINES9

 2.1 General Safety Practices9

 2.2 Safety Information9

3 RECEIVING, UNPACKING, AND STORAGE INSTRUCTIONS10

 3.1 Receiving Equipment 10

 3.2 Unpacking and Preparation (LABTEK™ N2-70 Series) 10

 3.3 Storage Instructions 11

4 SITE AND UTILITY REQUIREMENTS11

 4.1 Electrical Requirements 11

 4.2 Site Specifications 11

5 SYSTEM INSTALLATION12

 5.1 Installation 12

 5.1.1 LABTEK™ N₂-70L Detail Drawing 13

 5.1.2 LABTEK™ N₂-70TRI Detail Drawing 14

 5.1.3 LABTEK™ N₂-90 Dual Detail Drawing 15

6 SYSTEM DESIGN16

 6.1 Specifications (LABTEK™ N₂-70L) 16

 6.2 Specifications (LABTEK™ N₂-70tri) 17

 6.3 Specifications (LABTEK™ N₂-90 Dual) 18

 6.4 Standard Features 18

 6.4.1 Air Compressor 19

 6.4.2 Compressed Gas Filtration 19

 6.4.3 Zero-Loss Condensate Drain 19

 6.4.4 Safety Relief Valves 19

 6.4.5 Integrated Storage Tank(s) 19

 6.4.6 Automatic Cut-In/Out 19

 6.4.7 PLC User Touchscreen 19

 6.4.8 Ethernet Connection 19

 6.4.9 Outlet Gas Regulator 19

7 SYSTEM CONTROLS, DISPLAY, AND COMMUNICATIONS20

 7.1 Home Screen 20

 7.2 Calibrating Touchscreen 20

 7.3 Powering On/Off 20

 7.4 Starting/Stopping 21

 7.4.1 Filling 21

7.5	System Run Hours	21
7.6	Trending Graphs	22
7.7	Passcode Screen	22
7.8	Menu Screen	23
7.9	System Information Screen	23
7.10	System Settings	23
7.10.1	Sensor Calibration	24
7.10.2	O2% Sensor Auto-Calibration	25
7.11	Alarm Settings.....	26
7.11.1	High O ₂ Content Alarm	26
7.11.2	Low N ₂ Pressure Alarm.....	26
7.11.3	Low Dry Air Pressure Alarm	26
7.12	Alarm Status.....	26
7.13	Filter Replacement History	27
7.14	Filter Change	27
7.15	N2 Pressure Load/Unload Settings	28
7.16	Dry Air Pressure Load/Unload Settings (Dual and tri gas Units)	29
7.17	Troubleshooting Menu	29
7.18	Communication Settings for Ethernet Connection	30
7.18.1	Remote Access.....	30
7.18.2	MODBUS Communication.....	31
8	NITROGEN GENERATOR OPERATIONS	33
8.1	Start-up	33
8.1.1	Initial Start-Up	33
8.1.2	Normal Start-up	34
8.2	Shutdown	34
9	SYSTEM MAINTENANCE	35
9.1	LABTEK™ N2-70 Series	35
9.1.1	Air Intake Filters.....	35
9.2	Particulate and Coalescing Filter	36
9.3	Activated carbon filter	36
9.4	LABTEK™ N2-70 Series Filter Replacement	37
10	KEY CONTACTS.....	38
11	FAQS	39
11.1	Power Issues	39
11.2	Pressure Issues	39
11.2.1	Nitrogen Pressure Check:	39
11.2.2	Pressure Regulation Check:.....	39
11.3	Gas Leaks.....	39
11.4	General Issues	40

-----Notes-----

1 INTRODUCTION

1.1 PURPOSE

South-Tek Systems welcomes you to the exciting world of nitrogen generators! We provide leading edge technologies in **Pressure Swing Adsorption (PSA)** nitrogen generators that produce nitrogen on demand. The technology can reduce nitrogen gas costs by as much as 90% versus purchasing the gas from a supplier. We develop PSA systems worldwide that are utilized in industrial, lab, restaurants, fire-protection, educational, and military facilities. We pride ourselves in our ability to communicate and engineer nitrogen generation systems to meet specific requirements of our customers!

At South-Tek Systems, we engineer simple, turn-key generators to provide cost-effective means of producing nitrogen gas. The technology is based on years of continuous R&D on how to most effectively utilize carbon molecular sieve (CMS) to filter the nitrogen from oxygen in compressed air. We use the highest quality CMS provided to the market which goes through extensive in-house quality testing procedures. Our design principles require clean dry compressed air alternating through two adsorption pressure vessels packed with CMS. We have engineered our nitrogen generator with minimum maintenance and care requirements to provide our customers with years of confidence and reliability.

The nitrogen generator comes individually tuned, tested, and certified to meet the customer's specified nitrogen flow rate and purity using our Data Acquisition System (DAS). The certification and data analysis provides the necessary criteria to replicate a successful field installation. The systems are turn-key with detailed installation drawings, an instruction manual, and phone/text support. We have field service, commissioning, and other engineering services available to provide support any way we can!

**The installer and the user should read this manual in its entirety.

1.2 ABOUT SOUTH-TEK SYSTEMS

South-Tek Systems, founded in 1997, is a nitrogen generator manufacturer, designing and producing nitrogen generating systems for worldwide distribution.

Why not generate nitrogen at your own facility for a fraction of the cost versus endlessly paying for bulk liquid or delivered gas cylinders? We manufacture a full line of nitrogen generating equipment including:

- [The N2 GEN@ Series](#) with generators ranging from the compact 1 LPM tabletop lab generator on up to a 50,000 SCFH unit.
- [The BeerBlast™ Mixed Gas Dispense System](#) for restaurants and bars seeking the perfect draft pour.
- [The TireBlast™ Nitrogen Tire Filling System](#) for automotive and tire shops seeking optimal tire pressure maintenance and fuel economy
- [The N2-Blast™ Corrosion Inhibiting Systems](#) for Fire Protection Industries seeking solutions to preventing corrosion within the piping system

With purities ranging from 95% up to 99.999%, we provide nitrogen generators that are sure to suit your needs. For more information about our complete nitrogen generator capabilities, please visit www.southteksystems.com.

1.3 AUDIENCE

This manual is intended for Installer/Equipment Operator/Supervisory Staff and should be read in its entirety prior to operation. Please contact South-Tek Systems for any operation and maintenance questions.

1.4 LIMITS OF LIABILITY

The buyer's exclusive remedy for all claims shall be for damages, and the seller's total liability for any and all losses and damages arising out of any cause whatsoever including, but are not limited to, defective performance of the system, (whether such claim be based in contract, negligence, strictly liability, or other tort) shall in no event exceed the purchase price of the system in respect of which such cause arises or, at the seller's option, the repair or replacement of such; and in no event shall the seller be liable for incidental, consequential or punitive damages resulting from any such cause.

The seller shall not be liable for, and Buyer assumes all liability for, the suitability and the results of using nitrogen by itself or in any manufacturing or other industrial process or procedure, all personal injury and property damages connected with the possession, operation, maintenance, other use or resale of the System. Transportation charges for the return of the System shall not be paid unless authorized in advance by Seller.

NOTE: Any MODIFICATIONS made by the customer without the written consent of South-Tek Systems will void the product's design specifications.

1.5 SERVICE RETURN POLICY

If the system cannot be repaired at the site, and it is necessary to return a system for service, the following procedures must be followed:

- The owner must obtain a written **Return Material Authorization** number, which references the model and serial number, from South-Tek Systems. No items will be accepted for service or credit unless prior written authorization has been issued by South-Tek Systems.
- All items are to be returned with the original packaging material if possible. Make sure that all items are packaged for safe return to South-Tek Systems. South-Tek Systems will not be responsible for damages, which occur in transit. Any damage that occurs to the system because of failure to adhere to this procedure will be the sole responsibility of the customer. Contact South-Tek Systems for a return shipping address.
- Shipping charges must be prepaid on all returns.

2 SAFETY GUIDELINES

The following section outlines the basic safety considerations regarding installation and operation of the nitrogen generator. For additional safety information regarding other equipment used in conjunction with the nitrogen generator, such as air compressors, dryers, boosters, etc., please refer to the individual manufacturer recommendations and safety guidelines.

2.1 GENERAL SAFETY PRACTICES

Read carefully and act accordingly before installing, operating, or repairing the unit.

- Operator must use safe working practices and rules when operating the nitrogen generator.
- The owner is responsible for keeping the unit in safe operating condition at all times.
- Always use approved parts when performing maintenance and repairs. Make sure that replacement parts meet or exceed the original parts' specification.
- Only authorized, trained, and competent individuals can perform installation, operation, maintenance, and repair.
- Completely isolate incoming and outgoing pressures to the generator, and make sure to depressurize the service/repair section prior to performing any mechanical work, including changing the filters. The nitrogen generator's exhaust gas and/or any venting gas must be vented to the outside or to a large, well-ventilated room to avoid suffocation due to lack of oxygen.
- Safety glasses should be worn if the cabinet door is open while the machine is operating.
- Use ear protection when the equipment is operating.

WARNING: Pressurized gases are contained within the generator, the receiver, and product tanks. Pressurized gases are dangerous and may cause injury or death if handled or used inappropriately.

- Never allow pressurized gas to exhaust from an unsecured hose. An unsecured hose may exhibit a whipping action, which can cause serious injury. If a hose should burst during use, immediately close all isolation valves if it is safe to do so and power down the unit.
- Never disable or bypass any safety relief valves.
- Always make certain that the nitrogen generator is disconnected from the supply power prior to performing any electrical work.

NOTE: Always follow local and site safety regulations in conjunction with this manual.

Correct use of the nitrogen generator is important for your personal safety. Incorrect safety practices can cause damage to yourself and/or to the equipment.

2.2 SAFETY INFORMATION

Nitrogen is not a poisonous gas, but it should not be directly inhaled. In high concentrations it can cause asphyxiation. Ensure that the unit is installed within a well-ventilated room, one that is not sealed off from normal working space air changes.

All personnel involved with installation, operations, and maintenance of the nitrogen generator must follow safe working practices, OSHA, and local health/safety code regulations during the installation, operation, and maintenance of the unit.

Warnings:

- This manual shall be read in its entirety before installing and operating the nitrogen generator to prevent accidents and damage.
- Contact South-Tek Systems if there is a problem that you cannot solve with this manual.
- Use the nitrogen generator in accordance with its designed purpose.
- Qualified personnel are permitted to perform installation, maintenance, and repairs. Work performed by unqualified persons shall result in a voided warranty.
- Do not tamper with, experiment on, or exceed the technical specifications of the equipment.

3 RECEIVING, UNPACKING, AND STORAGE INSTRUCTIONS

3.1 RECEIVING EQUIPMENT

The nitrogen generator and all components are securely packed to minimize possibility of damages during shipment. The contents of the shipment should be inspected upon delivery to assure that no damage has taken place during transit. Save the packaging material, as it can be reused to return the generator. LabTek crates were designed to handle annual return shipments. If any components are found to be damaged, the carrier should be notified immediately.

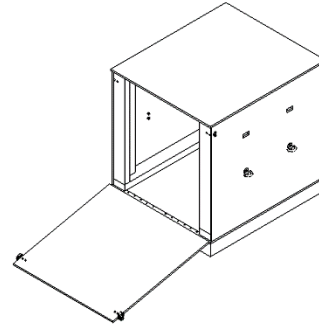

Figure 1: Removal from Crate

Important Note: DO NOT DISPOSE OF THE CRATE, this crate was designed to be used for returning the equipment to the manufacturer for service or replacement. Charges may incur if the crate must be replaced.

The individual pieces should be checked against the packing list. If any discrepancy is found, contact your local distributor or South-Tek Systems at (888) 526-6284. Please include the model number and the serial number with all correspondence.

3.2 UNPACKING AND PREPARATION (LABTEK™ N2-70 SERIES)

The LABTEK™ N₂-70L, N₂-70 Tri or N₂-90 Dual will be packaged in a crate. Open the container and inspect all parts for any damage upon receipt. Identify and verify that all parts listed on the packing list are present and undamaged. Any visual damages should be immediately documented (with photos) and immediately sent to the shipping company. South-Tek Systems (STS) is not responsible for damages that have occurred during the shipping and handling of the LABTEK™ N₂-70L, N₂-70T or N₂-90D. Then, contact STS at (888) 526-6284 to assess the damages only after the shipping company has been notified.

To remove the LABTEK™ generator from the wooden shipping crate, unlock the crate by releasing the two latches holding the crate door in an upright position. Carefully lower the door and set it on the floor. The front door will now act as a ramp for the unit. Roll the unit forward until it meets the crate door and gently lift the front of the unit up and guide it forward to begin rolling the unit down the ramp. The rear rollers will now easily clear the crate door with the weight of the unit guiding it down the ramp. The use of a floor jack is advisable to move the crate to its final location before unloading.

Until Installation:

- The LABTEK™ generator can be stored inside the container until installation. For extended storage of over a month, open and insert desiccant bags as needed to prevent moisture buildup.
- Store the LABTEK™ generator in a dry and climate controlled (60-80°F) room.
- Always keep the generator in an upright position.
- Do not connect power cable until this manual has been read completely and all connections are made as stated within.
- Keep all gas lines dry so moisture does not enter the generator upon hookup.
- Never place/stack objects on top of the LABTEK™ generator unless indicated by the manufacturer.

3.3 STORAGE INSTRUCTIONS

If the unit is not to be installed until a later date, a safe dry storage location is needed, preferably inside a controlled environment. Place desiccant packets in the cabinet near the electrical panel and PLC to keep moisture from damaging the electronics. Do not store around moving objects that could fall or damage unit.

4 SITE AND UTILITY REQUIREMENTS

4.1 ELECTRICAL REQUIREMENTS

The LABTEK™ TYP7P series standard unit requires 208-230V / 50-60hz / 1ph connection. units come standard with a built-in 25A overcurrent protection device and designed for use with a L6-30 locking power cable. The system has a UL 508A ICP approval. Electrical schematic available upon request.

4.2 SITE SPECIFICATIONS

For installation, select a non-hazardous area indoors which remains above 40 °F / 4°C and below 85 °F / 29 °C. Adequate space should be provided around the generator for access, cooling and venting, and routine maintenance. Provide at least 12" of clearance for cooling fans along the back and sides of the cabinet.

5 SYSTEM INSTALLATION

5.1 INSTALLATION

The LABTEK™ TYP7P Series need to be installed on hard, flat surfaces, capable of supporting 400+ lbs. It is not required to be anchored, but always follow any site or local codes regarding securing equipment.

Double-check that all connections are tightened before turning on the system. Check the connection fittings once the system is on and ensure no leak is present.

Once connections are all secure, plug in the power cord. The initial start-up will require up to 15 minutes to fully pressurize the internal storage tank to the correct level. If the tank does not read 100+ PSI after 15 minutes, it may be a sign that there is a leak somewhere in the system. The pressure can be viewed via the PLC main screen. Once the tank is full, the system will automatically go into a load/unload mode and will be ready for standard operation.

Note: Line leaks will cause the LABTEK™ generator to run excessively, increasing its maintenance, and shortening its life.

The LABTEK™ gas generator utilizes a single nitrogen output. Some models may have a second outlet port for dry air or a third outlet for zero air. Use only quality tubing and fittings for all connections.

A condensate drain for the generator is located on the back of the unit. The condensate drain can be plumbed to a traditional drainage area if present. It is the responsibility of the installer to plumb these drains to an area where standing water is trapped, or a drain is located.

For specifications on connections or drain amounts see the specification tables below.

If your system requirements are more involved, please consult with South-Tek Systems for a customized installation drawing.

5.1.1 LABTEK™ N₂-70L Detail Drawing

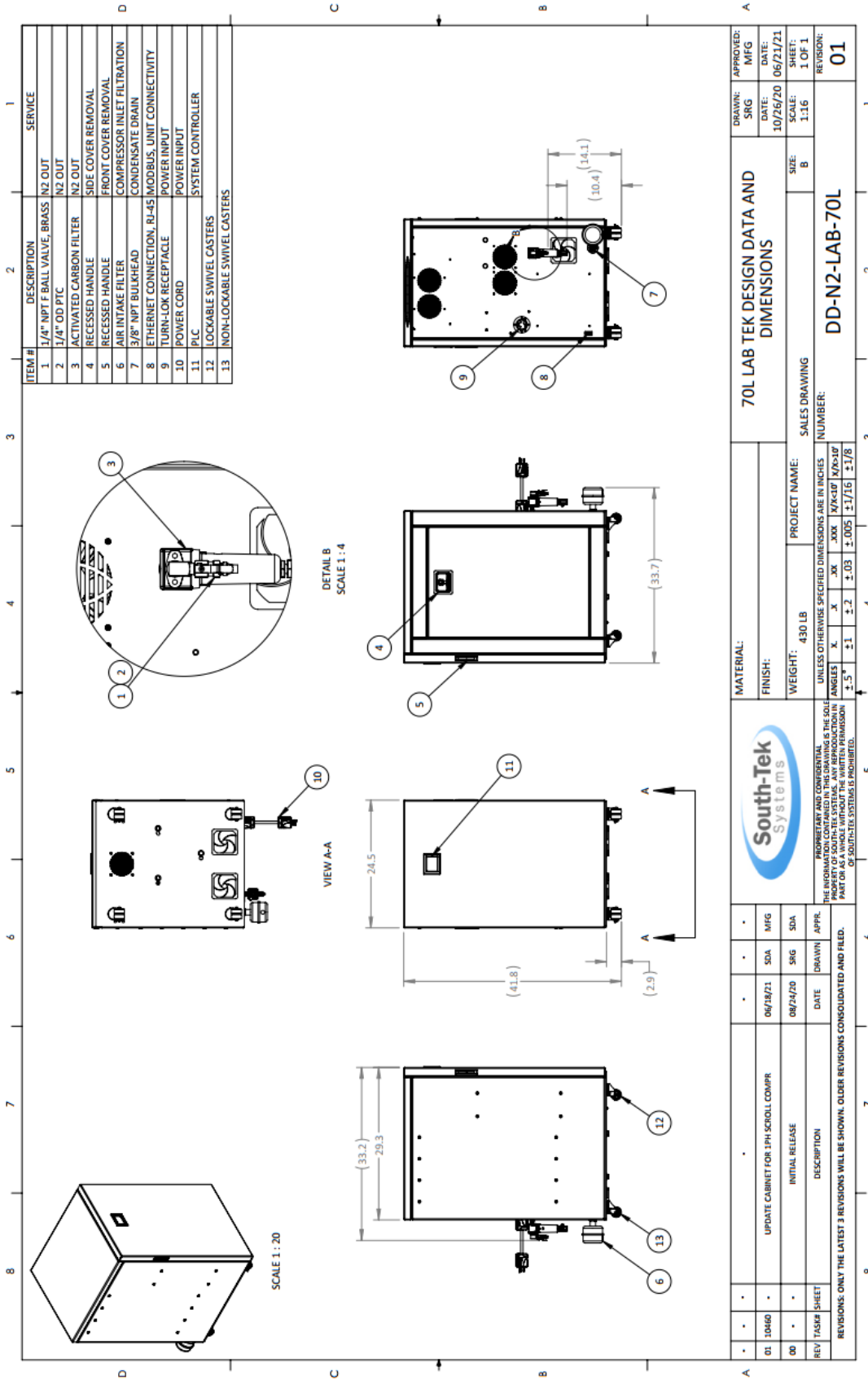

5.1.2 LABTEK™ N₂-70TRI Detail Drawing

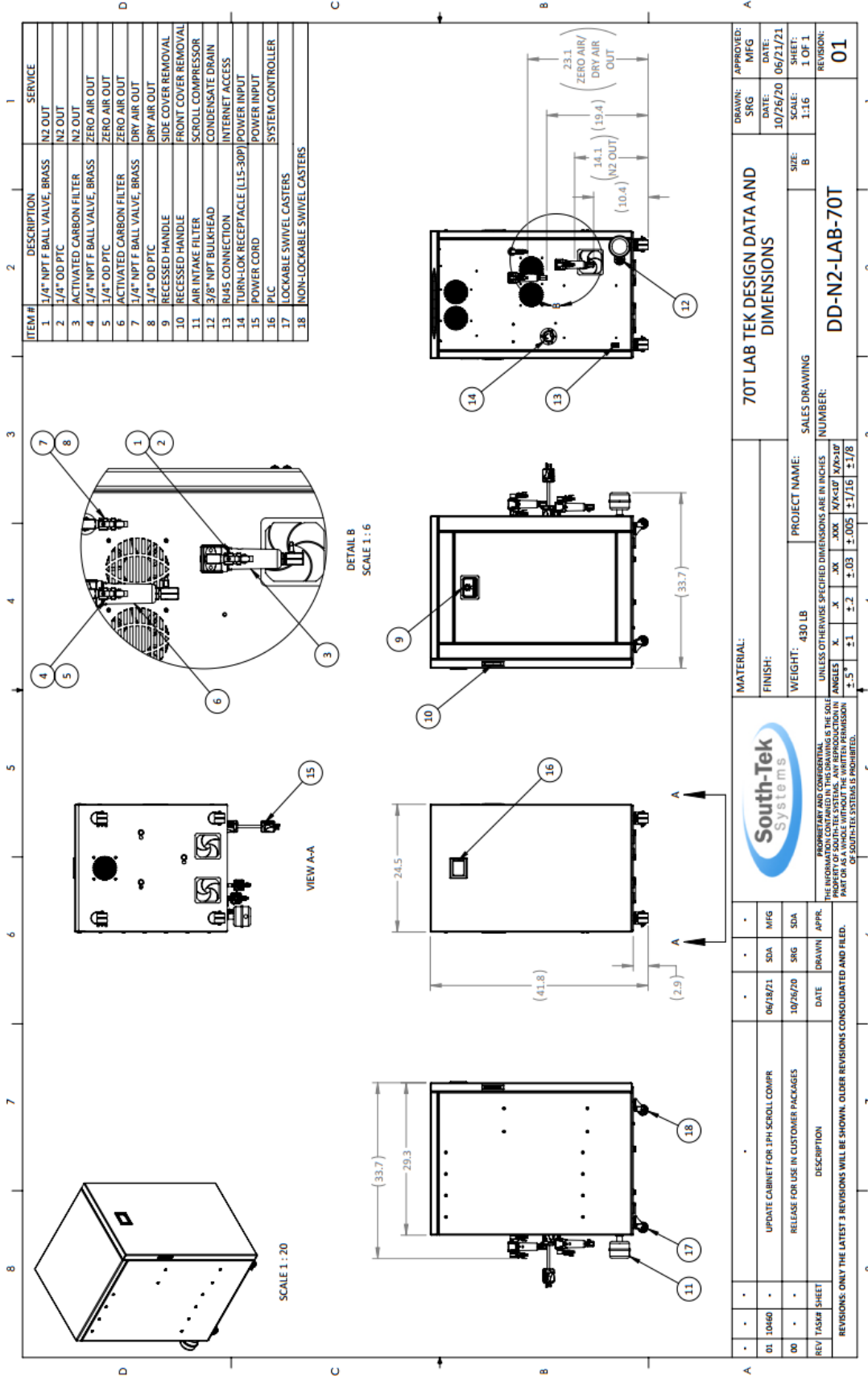

Revision: 01
Revision Date: 07/07/2021

5.1.3 LABTEK™ N₂-90 Dual Detail Drawing

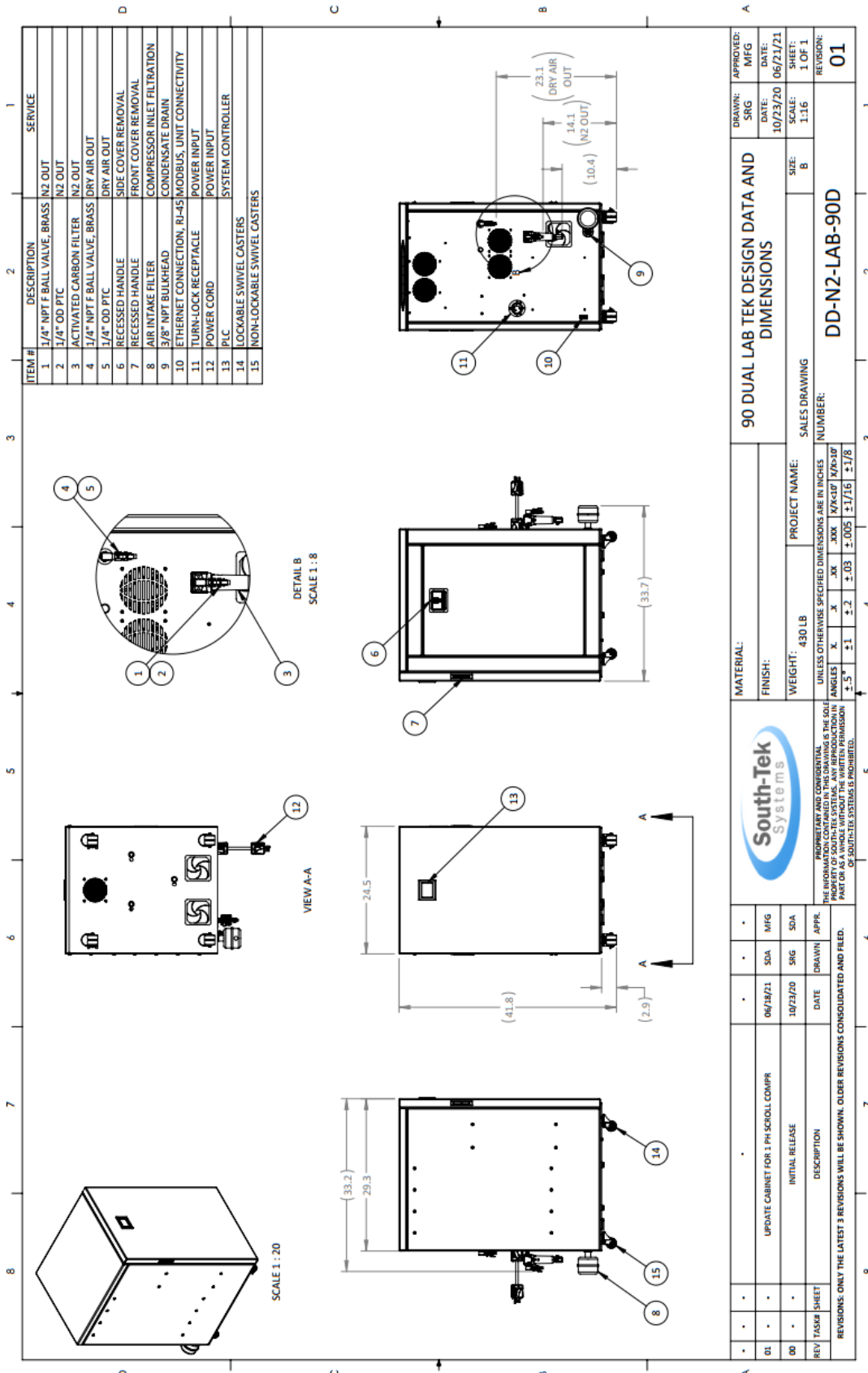

REV	TASK#	SHEET	DATE	DRW	APPR.	DESCRIPTION
01			06/18/21	SDA	MFG	UPDATE CABINET FOR 1 PH SCROLL COMP
00			10/23/20	SRG	SDA	INITIAL RELEASE

REVISIONS: ONLY THE LATEST 3 REVISIONS WILL BE SHOWN. OLDER REVISIONS CONSOLIDATED AND FILED.

MATERIAL:		90 DUAL LAB TEK DESIGN DATA AND DIMENSIONS	
FINISH:	PROJECT NAME:	SALES DRAWING	SIZE:
WEIGHT: 430 LB	UNLESS OTHERWISE SPECIFIED DIMENSIONS ARE IN INCHES	B	B
	ANGLES	NUMBER: DD-N2-LAB-90D	
	±.5° ±1		
	±.2 ±.03		
	±.16 ±.18		

APPROVED:	DATE:	SHEET:	REVISION:
SRG	10/23/20	1 OF 1	01
MFG	06/21/21		
SCALE:	SCALE:		
1:16	1:16		

6 SYSTEM DESIGN

6.1 SPECIFICATIONS (LABTEK™ N₂-70L)

LABTEK™ 70L – Specifications	
Nitrogen Purity	95%-99.500% (Factory set per customer spec)
N ₂ Storage Pressure	100-125 PSIG
N ₂ Flowrate	Up to 70 LPM (Factory set per customer spec)
N ₂ Out Port Size	1/4" PTC Female
Electrical	208-230V / 50-60Hz / 1 Phase / 18.5A; 25 Amp Breaker
Electrical Connector	L6-30
Compressor	Integral / Oil-Free
Ambient Temperature	40° to 85°F
Noise Level (dbA)	< 59 dbA
Size	41.75" H x 24.5" W x 29.5" D (Cabinet Dimensions, Drawing supplied)
Weight	Appx. 430 lbs
Condensate Outlet Port	3/8" NPT Female

6.2 SPECIFICATIONS (LABTEK™ N₂-70TRI)

LABTEK™ N ₂ -70 Tri Gas – Specifications	
Nitrogen Purity	95%-99.500% (Factory set per customer spec)
N ₂ Storage Pressure	100-125 PSIG
N ₂ Flowrate	Up to 19 LPM (Factory set per customer spec)
N ₂ Output Port Size	1/4" PTC Female
Electrical	208-230V / 50-60Hz / 1 Phase / 18.5A; 25 Amp Breaker
Electrical Connector	L6-30
Compressor	Integral / Oil-Free
Ambient Temperature	40° to 85°F
Noise Level (dbA)	< 59 dbA
Size	41.75" H x 22.5" W x 28.25" D (Cabinet Dimensions)
Weight	Appx. 430 lbs
Dry Air Pressure	110-125 PSIG
Dry Air Flowrate	Up to 26 LPM (Factory set per customer spec)
Dry Air Pressure Dewpoint	-20° F
Dry Air Output Port Size	1/4" PTC Female
Zero Air Pressure	40-120 PSIG
Zero Air Flowrate	Up to 25 LPM (Factory set per customer spec)
Zero Air Dewpoint	-20° F
Condensate Outlet Port	3/8" NPT Female

6.3 SPECIFICATIONS (LABTEK™ N₂-90 DUAL)

LABTEK™ N ₂ -90 Dual – Specifications	
Nitrogen Purity	95%-99.500% (Factory set per customer spec)
N ₂ Storage Pressure	100-125 PSIG
N ₂ Output Port Size	1/4" PTC Female
Electrical	208-230V / 50-60Hz / 1 Phase / 18.5 Amp; 25 Amp Breaker
Electrical Connector	L6-30
Compressor	Integral / Oil-Free
Ambient Temperature	40° to 85°F
Noise Level (dbA)	< 59 dbA
Size	41.75" H x 22.5" W x 28.25" D (Cabinet Dimensions)
Weight	Appx. 430 lbs
Dry Air Pressure	110-125 PSIG
Dry Air Flowrate	Up to 67 LPM (Factory set per customer spec)
Dry Air Pressure Dewpoint	-20° F
Dry Air Output Port Size	1/4" PTC Female
N ₂ Flowrate	Up to 15 LPM (Factory set per customer spec)
Condensate Outlet Port	3/8" NPT Female

6.4 STANDARD FEATURES

The LABTEK™ TYP7P Series key features include the following:

- Integral Air compressor
- Compressed Gas Filtration
- Zero Loss Condensate Drain
- Pressure Swing Adsorption Beds
- Safety Relief Valves
- Integrated Storage Tank(s)
- Automatic Pressure Cut-in/Cut-out
- PLC User Touchscreen
- Ethernet Connection for MODBUS TCP/IP communications
- Outlet Gas Regulator(s)

6.4.1 Air Compressor

The air compressor is mounted internally to the cabinet and features engineered dampening system to reduce vibration and noise. It is an oil-less compressor with a durable suction filter. The recommended replacement on the pre-filter is 4000 run hours or every 1 year (whichever comes first). Dirtier environments may be required to be changed out more frequently. Consult your supplier for a different filter maintenance schedule if you are installing the generator in dirty environment.

6.4.2 Compressed Gas Filtration

The generator has three filters after the air compressor: particulate, coalescing, and a final nitrogen activated carbon filter. The particulate filter has a 1-micron filter element that will catch any of the larger particles. The Coalescing has a 0.01-micron filter element meant to remove any filter particulate or oil/water particles. These filters feature an auto drain that will drain the water captured after the air compressor. The drain is plumbed to a port on the back of the cabinet where the site should connect a drain tube. The Activated Carbon filter removes volatile organic compounds, odors, and other gaseous pollutants from the nitrogen.

6.4.3 Zero-Loss Condensate Drain

The supplied gas generator requires compressed air for each process. To ensure the best efficiency and reliability each 70L, 70T and 90D unit is supplied with a zero-loss condensate drain. The zero-loss function ensures compressed air is used to make nitrogen, dry air or zero air rather than creating a wasteful air loss.

6.4.4 Safety Relief Valves

Safety Relief Valves have been placed throughout the system to reduce the risk of over pressurization. They are put in place to minimize failure of other components. All relief valves come with an ASME stamp.

6.4.5 Integrated Storage Tank(s)

One three-gallon N₂ storage tank is housed inside the cabinet with manual ball valves and a pressure sensor. It is plumbed to an external push-to-connect fittings and a carbon adsorbing filter. A three-gallon dry air storage tank is also within the cabinet with manual ball valves and a pressure sensor. A final connection is supplied via a separate outlet fitting.

6.4.6 Automatic Cut-In/Out

The generator comes with a built-in pressure transducer that is tied into the PLC. This will provide a signal back to the PLC to put the system in a "Load", "Unload", and "Standby" modes depending on the pressure in the storage tank(s).

6.4.7 PLC User Touchscreen

There is an integrated PLC and HMI with a full-color touchscreen. It features smart and efficient coding to maximize the performance and intuitiveness of the system controls. It maintains the timing and sequencing of the valves to move compressed gas throughout the system. A visual touchscreen is included which displays information such as run hours, alarms, sensor readings, tank pressure, O₂ content, and graphs of historical data.

6.4.8 Ethernet Connection

Each gas generator is supplied with a PLC (RJ-45) ethernet connection. Connectivity via ethernet is described more in Section 7.18 – Communication Settings for Ethernet Connection for details on remote operating software or connection via MODBUS.

6.4.9 Outlet Gas Regulator

Each gas generator has been supplied with pressure regulator(s) on each gas outlet connection. The pressure regulators included give steady or reduced pressures. Depending on the LCMS brand many rely on consistent supply pressure from nitrogen, dry air or zero air.

7 SYSTEM CONTROLS, DISPLAY, AND COMMUNICATIONS

The nitrogen generator comes with controls and instrumentations uniquely programmed (proprietary to South-Tek) with a control sequence to effectively and efficiently generate high quality nitrogen on demand. It can be customized and engineered to meet specific needs. Any changes/customization must be performed/approved by South-Tek Systems or written approval must be obtained from South-Tek Systems. Unauthorized changes to the system will void all warranties and may cause damages to the system or cause it to malfunction.

This section describes the function of the major controls and instrumentation associated with the nitrogen generator. Do not attempt to alter any controls or instrumentations; any changes without South-Tek Systems' consent will void the performance specifications unique to the system.

The PLC is used for the control sequence of the valves and controls the nitrogen generator's functionality. All programs are proprietary, and password protected from the factory.

Note: Controls for supporting equipment, such as any external compressor, dryers or pumps are not included in this section. Please consult the original manufacturer's instructions for further information.

7.1 HOME SCREEN

The home screen displays relevant information regarding the nitrogen generator such as system status, nitrogen storage tank pressure, oxygen content, dry air pressure (for dual models), and run hours. The user can manually start/stop and navigate to either the "Menu", "Graph" or "Alarms Status" (if any alarms are enabled) screens.

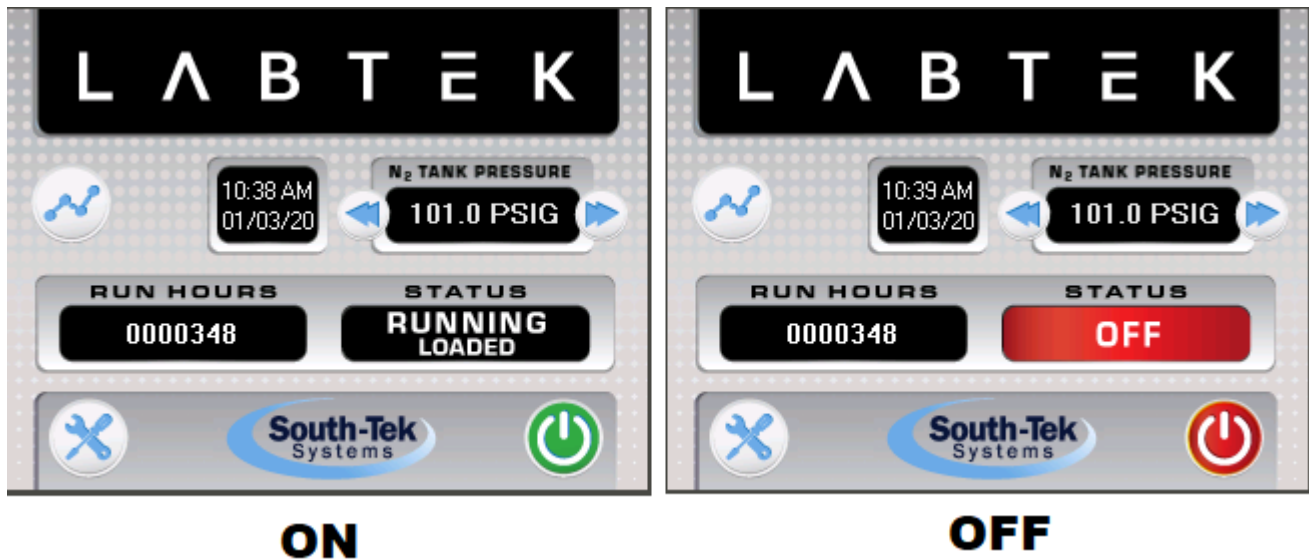

Figure 2: Home Screen

7.2 CALIBRATING TOUCHSCREEN

If the touchscreen is not responding or it is responding inaccurately, press and hold the South-Tek Systems logo on the home screen until a screen with two options appears. Press the bottom selection labelled "Calibrate Touchscreen" and press each yellow box accurately as they appear. The back of a pen or most types of touchscreen styluses can be used to achieve a more accurate press/calibration.

7.3 POWERING ON/OFF

Powering On/Off the unit should be done with an external power switch or disconnect, typically supplied by others.

7.4 STARTING/STOPPING

The nitrogen generator can be started and stopped on the controller touchscreen. The “Start/Stop” button is in the bottom-right corner of the home screen. When illuminated green, the unit has been started and is considered “On”. When illuminated red, the unit is “Stopped” and considered “Off”. To change from the “On/Off” state, **press and hold** the “Start/Stop” button, the switch will change colors, and the system status will update indicating a mode change.

When the system is stopped, all valves will return to the normal position. Power does not need to be removed from the system unless maintenance is being performed. It is recommended to close off the valve for the nitrogen and/or dry air outputs so that the pressure levels in the internal tank do not fall below the load pressure. Losing the tank pressure or leaving the system off for a long period of time may cause the oxygen content to fall out of specification for a brief period when the unit is restarted.

When the nitrogen generator is in the “On” state, it will automatically cycle through the adsorption beds to produce nitrogen to fill the storage tank. At the same time the compressor will make dry air using the membrane dryer, filling the dry air tank. Once the storage tank(s) reach the unload pressure setpoint (both unload pressure setpoints for dual/tri generators) it automatically goes into a “Unloaded” state, where it pauses the production of nitrogen. Once the storage tank pressure falls to the “Load” pressure, the system will automatically restart and begin producing nitrogen again.

7.4.1 Filling

When first started, the generator will go through a filling process if the nitrogen storage tank is below 100 PSIG. Once the nitrogen storage tank pressure is above 100 PSIG the unit will enter its normal process and is ready for use. If the generator seems to be stuck in this mode, check the system for external and internal leakage. With system isolated from process typical pressurization is less than 15 minutes for this product.

7.5 SYSTEM RUN HOURS

On the “Home Screen”, the system run hours is displayed in the bottom left-hand corner below the current time and date. The run hours are calculated when the system is cycling and producing nitrogen. The “standby hours” are not included but “unloaded hours” are considered part of the run time. Loaded run hours can also be viewed in system information

7.6 TRENDING GRAPHS

The “Graph” button on the “Home” screen will bring up historical trending data of the sensors included with the generator. Every generator will include a nitrogen pressure transducer; therefore, every unit will trend the nitrogen tank pressure. Dual/Tri generators will also have a reading dry air pressure and display dry air pressure graphs and trends. Other optional graphing displays include oxygen purity. Please contact South-Tek if other graphical displays are desired.

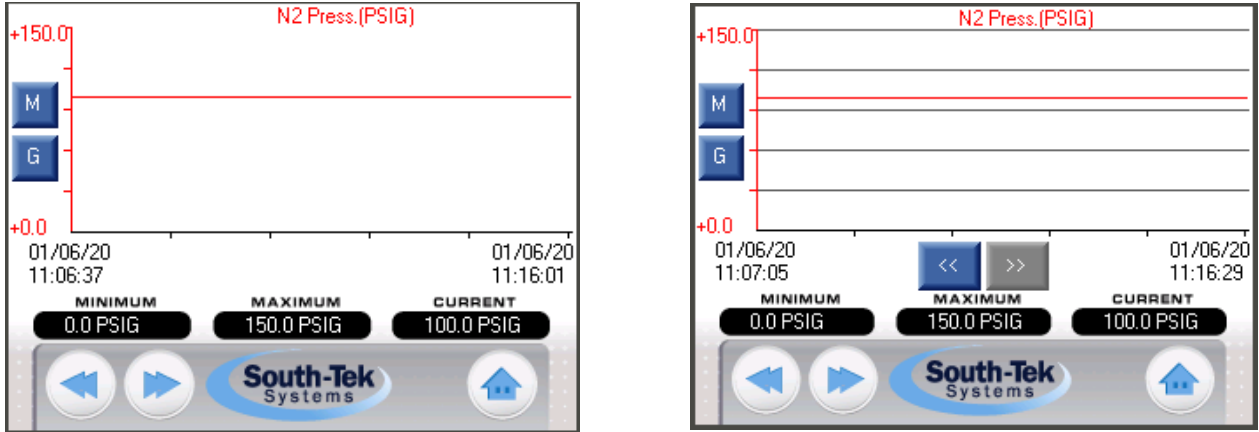

Figure 3: Left - Graph Screen, Right, Graph Screen with History Scroll and Grid Lines

The user can adjust the Y-axis scale (pressure reading range) by adjusting the minimum and maximum values in the lower left of these screens. Press the box and a numerical keypad will appear. Enter in the desired values and press enter. The graph will automatically adjust once the min and max values are entered.

The “M” button is for scrolling through the sensor history over time (X-axis) and the “G” button is to bring up horizontal gridlines. Press the “Next” button to go to the next graph or press the “Exit” button to return to the home screen.

7.7 PASSCODE SCREEN

The system requires a passcode to access the system menus or change factory settings. This passcode is a protection from accidental changes that may alter system performance or functions. To enter the passcode, press the entry bar, enter the passcode found on the second page of this manual, and press enter.

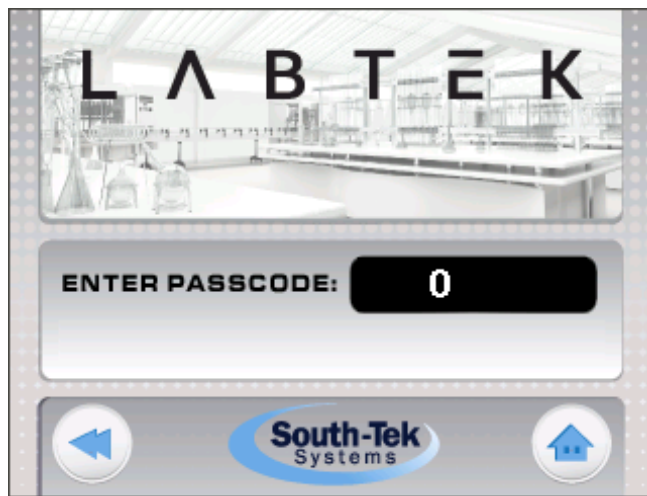

Figure 4: Passcode Screen

7.8 MENU SCREEN

The “Main Menu” screen (accessed from home screen), is password protected. Please consult the second page under “Revision History” of the provided hard-copy manual for the user password.

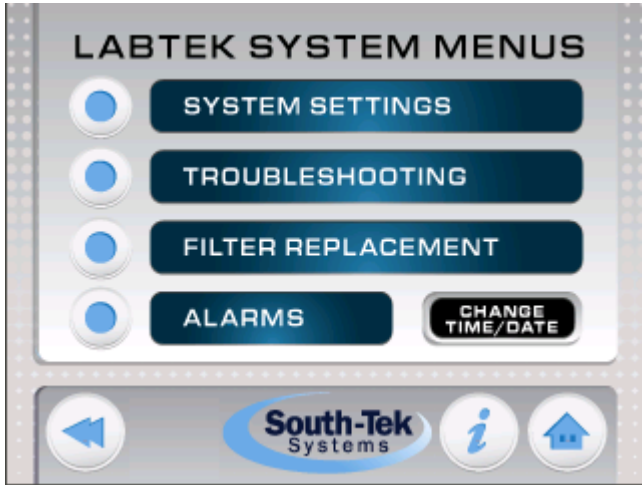

Figure 5: Main Menu Screen

Once access is granted to “Main Menu”, the user can access all options shown in the **above** figure. The information button in the bottom right of this screen can be used to access system information such as software version, product serial number, and manufacture/commission dates.

7.9 SYSTEM INFORMATION SCREEN

The “Information” screen will provide specific details such as current run hours, load hours, software version, manufacture build date, serial number, and date of commission.

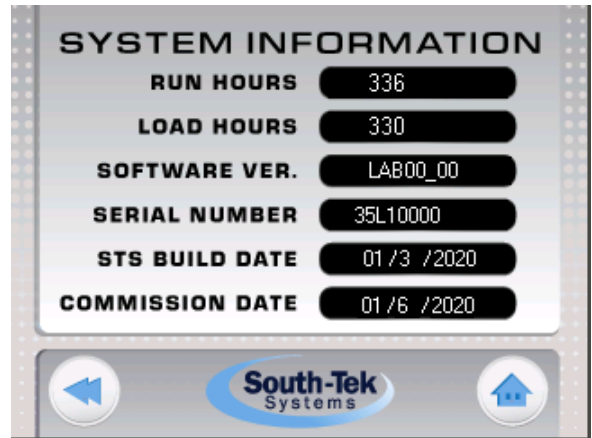

Figure 6: System Information Screen

7.10 SYSTEM SETTINGS

The System Settings menu includes settings that are essential to the proper operation of the generator. Any changes/customization to these must be performed/approved by South-Tek Systems or written approval must be obtained from South-Tek Systems.

Unauthorized changes may alter system performance and has the chance to void all warranties if not authorized by South-Tek Systems.

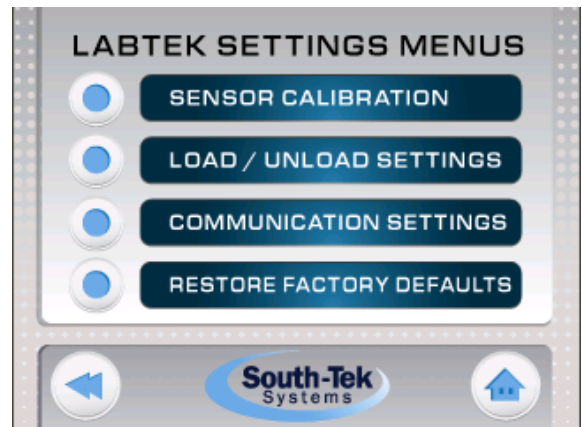

Figure 7: System Settings Menu

7.10.1 Sensor Calibration

The “Sensor Setup/Calibration” screen allows the user to calibrate sensors included with the nitrogen generator. Every unit will have a nitrogen storage pressure sensor and typically, the oxygen (O₂) sensor is recommended as an add-on. Dual generators will also be equipped with a dry air pressure sensor that requires calibration.

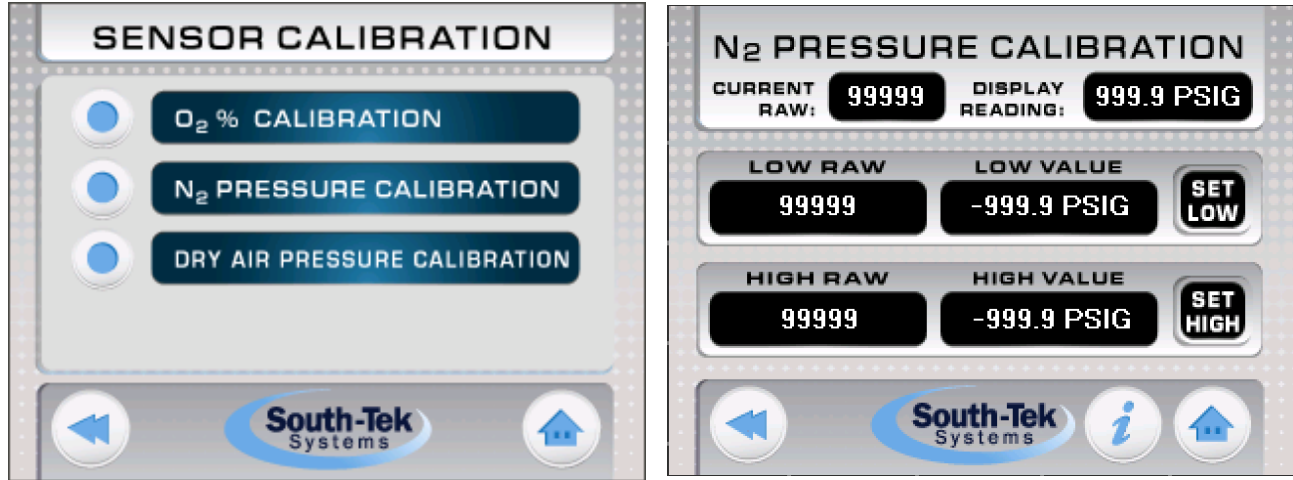

Figure 8: Left Screen - Sensor Calibration Selection, Right Screen - 2-Pt Calibration Values

All sensors are setup with a 2-point linear calibration. To setup the calibration, the user will need two known points. It is best to select two points at opposite ends of the sensor’s calibration range. The following charts is the recommended 2-Point Calibration range for the “Low” and “High” point.

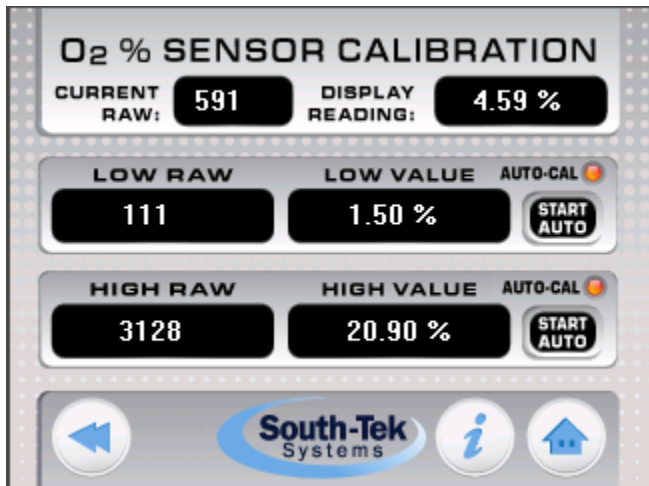

Figure 9: O2% Calibration Screen

Table 1: Recommended 2-Point Calibration Ranges

	Calibration Value Ranges	
	Low Point	High Point
Pressure	0-5 PSIG	100-150 PSIG
O ₂ %	0.5-1.5% O ₂	10-21% O ₂
O ₂ PPM	100 PPM	1000 PPM

The “Low Limit Raw” and “High Limit Raw” are determined by the “current raw” reading at the time the known calibration source is applied to the sensors. For example, when the known pressure is 0 PSIG to the pressure sensor, read the “Current Raw” value and enter that in the box next to the “Low Limit Raw” text. Then apply a known pressure of ~100 PSIG to the sensor and read the “Current Raw” value (which should be different – if not, the sensor or wiring connection may be bad) and enter that value in the box next to the “High Limit Raw” text.

Other notes for calibrating units with % O2 sensors:

1. Make sure certified gas is being used for the low point.
2. Clean, dry compressed air (20.9%) can be used for the high point.
3. Verify flow is only 1-2 scfh. Higher flow may damage the sensor.
4. Never block the outlet purge line – it is a ¼” OD polyethylene tubing that extends 12-18” from the output of the sensor.

7.10.2 O2% Sensor Auto-Calibration

The O2% Calibration screen has an option to auto-calibrate the high and low points. Two calibrated gases are required to perform this calibration, simply enter the calibration gas value, apply the entered calibration gas to the sensor at 100 PSIG, then press and hold the “Start Auto” button on the point desired for calibration.

The auto-calibration will run for three minutes, then set the raw value automatically. It will also sound an audible beep confirming when the auto-calibration is complete. The auto-calibration can be cancelled at any point during these three minutes by pressing the cancel button or pressing the “Start Auto” of the other point.

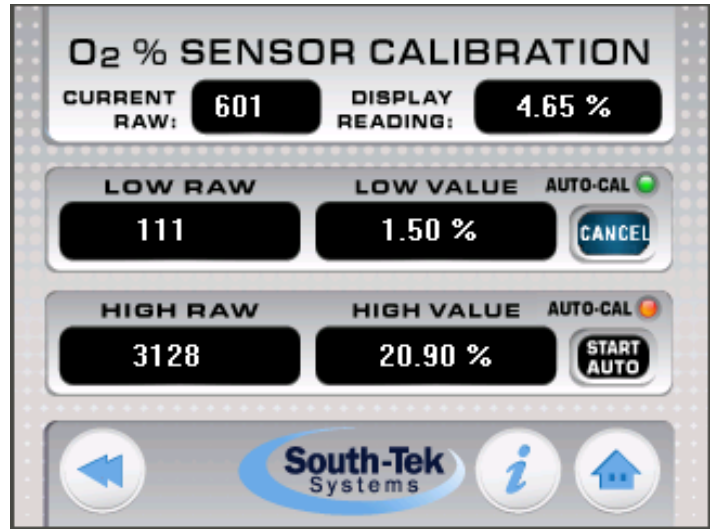

Figure 10: O2% Calibration Screen – Auto-Calibration in Progress

7.11 ALARM SETTINGS

The “Alarms/Filter Parameters” menu displays the High O₂ alarms, low-pressure alarm setpoints, and the filter alarm settings. The toggle next to each alarm allows the user to select which alarms they desire to enable, if any.

If any alarms are enabled and their conditions are met, it will trigger the 24V alarm relay as well as an audible alarm buzzer. To simulate this, see **Troubleshooting Menu**.

The bell button on the home screen allows access to the Alarm Status screen, if any alarms are enabled this button will display on the home screen.

7.11.1 High O₂ Content Alarm

If enabled, the “High O₂ Content” Alarm is triggered when the current O₂ purity reading is higher than the setpoint value for the amount of time designated by the “Alarm Delay”. The setpoint of this alarm should not be set lower than the specifications for this generator and will not actively monitor the O₂ content until after the unit has completed its filling process (See section **Filling**).

7.11.2 Low N₂ Pressure Alarm

If enabled, the “Low N₂ Pressure” alarm is triggered when the current nitrogen tank pressure reading is below the setpoint value. The setpoint of this alarm cannot be set higher than 100 PSIG and will not be active until after the unit has completed its filling process (See section **Filling**).

7.11.3 Low Dry Air Pressure Alarm

If enabled, the “Dry Air Pressure” alarm is triggered when the current Dry Air pressure reading is below the setpoint value for the amount of time designated by the “Alarm Delay”. The setpoint of this alarm should not be set higher than 100 PSIG and will not be active until after the unit has completed its filling process (See section **Filling**).

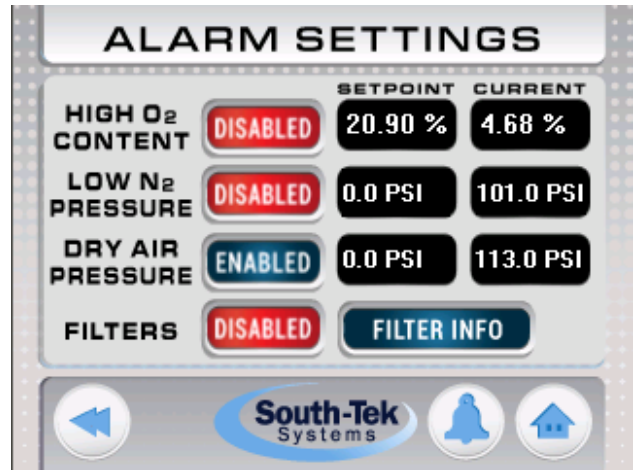

Figure 11: Alarm Settings Screen

7.12 ALARM STATUS

The red “Alarm” button (bell button on the home screen) will bring up a secondary “Alarm Status” screen. Here, the user can get a read out of the current alarm statuses. The user can get more information by going to “Filters Info”, “Alarm Details”, “Alarm History”, or “Clear History”.

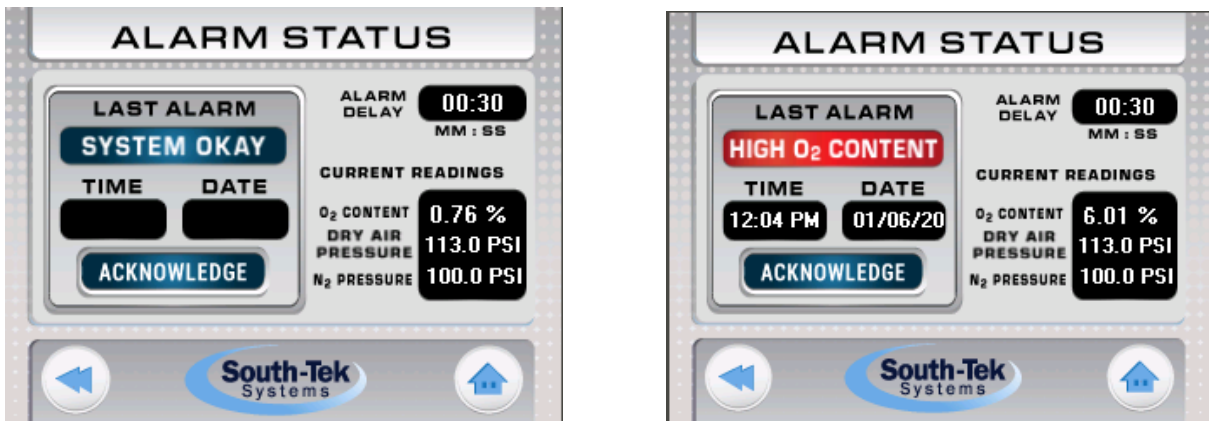

Figure 12: Alarm Status

7.13 FILTER REPLACEMENT HISTORY

The “Filter Replacement History” screen will display the current filter status of either “OK” or “REPLACE” and when the filter was changed last. If “REPLACE” is displayed, it is advisable to change out the corresponding filter as soon as possible.

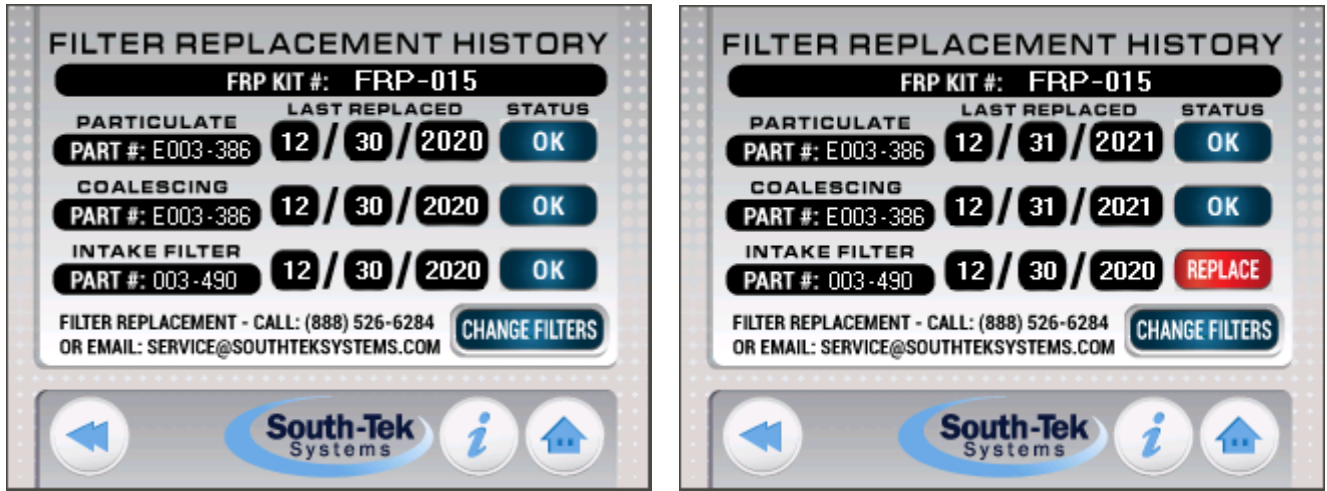

Figure 13: Element Last Change Date (Left), Replacement History with intake filters that require changing (Right)

If the filter was changed at a previous date, that date can be manually entered on this page or, if the filters are currently being changed, the Change Filters button can be pressed to access the Filter Change screen.

7.14 FILTER CHANGE

The Filter Change screen will display the factory recommended filter element replacement schedule. It will also display the current status of each individual filter – “OK” or “REPLACE”. The user can reset the filters by pressing and holding the reset buttons.

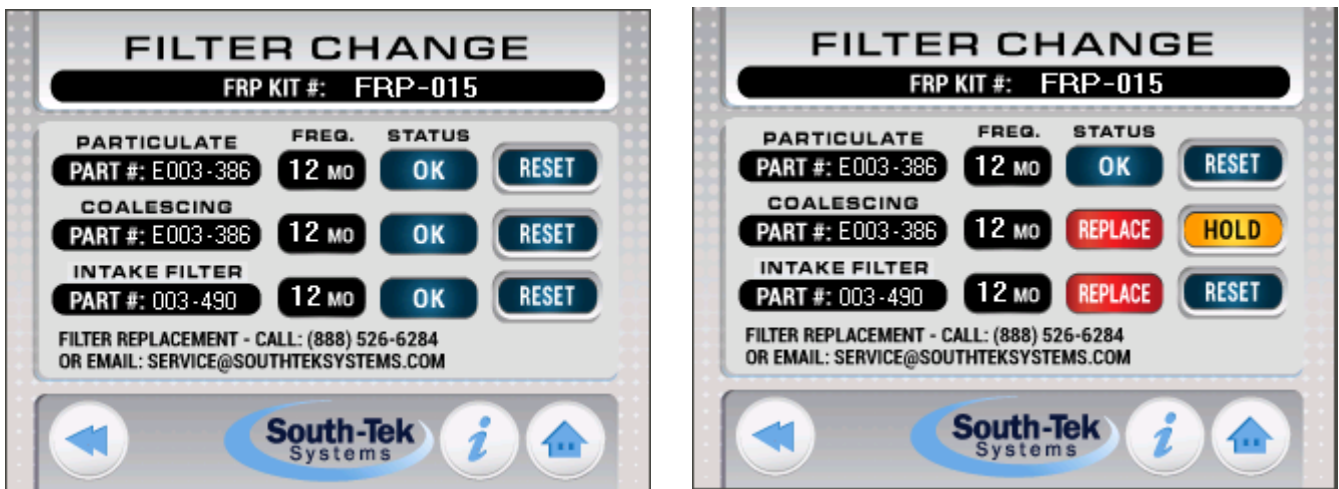

Figure 14: Filter Change Screen

7.15 N2 PRESSURE LOAD/UNLOAD SETTINGS

The nitrogen generator is equipped with a nitrogen pressure transducer to measure the nitrogen storage tank pressure. It is connected to the controller and the value is used to determine the load and unload pressures, allowing the system to be more energy efficient. When the nitrogen storage tank reaches the “Unload Setpoint” pressure, the generator will go into an “Unloaded” mode, where the delivery of air to the nitrogen generator will stop after the “Load Delay” time finishes unless dry air is still calling the system to remain loaded (for dual models only). The system will stay unloaded until the nitrogen storage tank pressure falls to the “Load Setpoint” pressure or until the “Shutdown Delay” time is reached. At the “Load Setpoint”, the nitrogen generator will resume separating oxygen from the compressed air and delivering nitrogen to the storage tank. If the Shutdown Delay time is reached after staying unloaded for the duration the compressor will shut down and the generator will enter a standby mode until a load setpoint pressure is reached or power is cycled. After coming out of a standby mode, pressure may drop lower than normal as the compressor takes a short time to start up. This typically lasts less than 30 seconds.

Note: All Load / Unload settings are factory set and should not be adjusted without contacting South-Tek Systems.

Adjusting the settings may alter the nitrogen purity and flow capabilities. To see what the factory setpoints are, the user can press the “Menu” button from the main screen, then “Load/Unload Settings”.

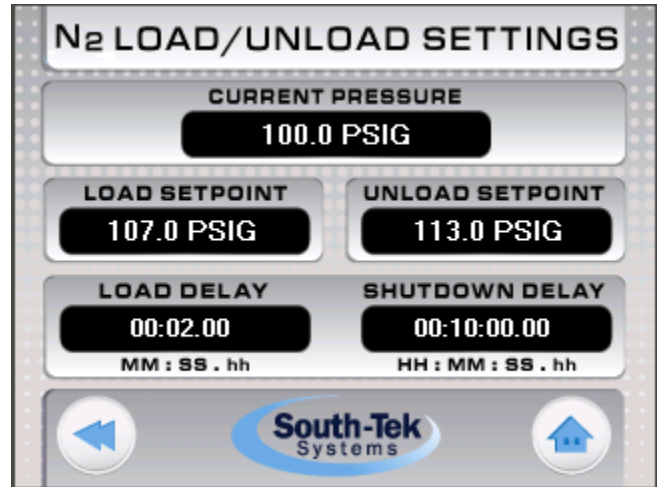

Figure 15: Nitrogen Load/Unload Settings Screen

7.16 DRY AIR PRESSURE LOAD/UNLOAD SETTINGS (DUAL AND TRI GAS UNITS)

Dual and Tri gas model generators are equipped with a dry air pressure transducer to measure the dry air tank pressure. It is connected to the controller and the value is used to determine the load and unload pressures, allowing the system to be more energy efficient. When the nitrogen storage tank reaches the “Unload Setpoint” pressure, the generator will go into a “Unloaded” mode, where the delivery of air to the dryer will stop after the “Load Delay” time unless the nitrogen demand is still calling the system to remain loaded. The system will stay unloaded until the dry air pressure falls to the “Dry Air Load Pressure”. At the “Dry Air Load Pressure”, the dry air generator will resume delivering dry air to the storage tank.

Note: The Load / Unload settings are factory set and should not be adjusted without contacting South-Tek Systems.

Adjusting the settings may alter the dry air output in dryness, pressure and flow capabilities.

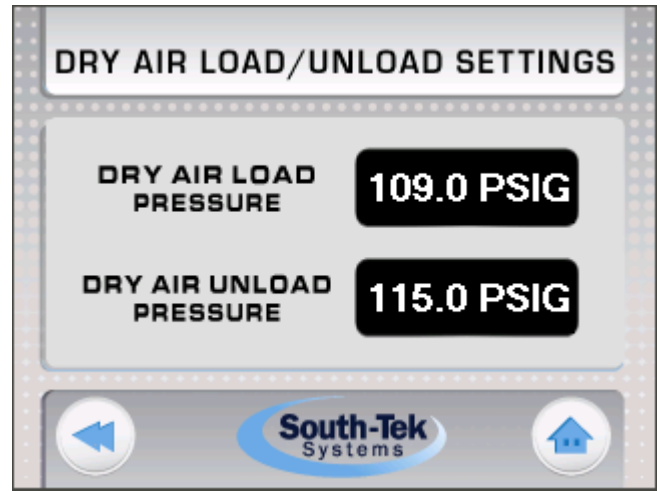

Figure 16: Dry Air Load/Unload Settings Screen

7.17 TROUBLESHOOTING MENU

The “Maintenance Menu” allows the user to individually toggle each valve to verify that they are working. It is recommended to have the unit in the “Stopped” mode and the nitrogen outlet valve (from the nitrogen generator) closed prior to toggling the valves individually. Make sure to reset the valves to “Off” prior to restarting the system.

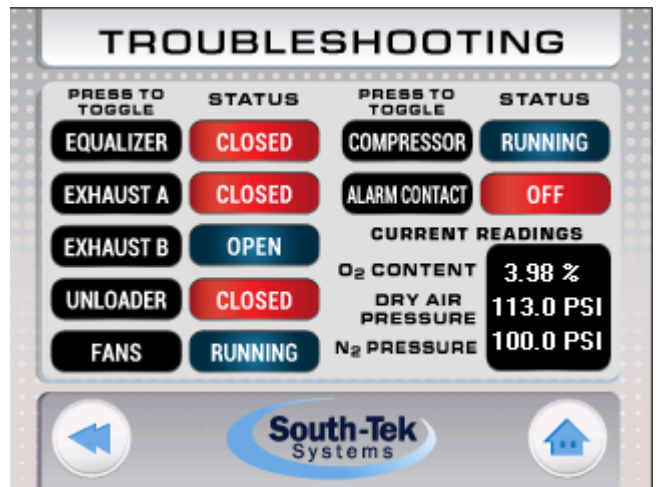

Figure 17: Maintenance Menu Screen

7.18 COMMUNICATION SETTINGS FOR ETHERNET CONNECTION

An ethernet connection is included with the nitrogen generator. This allows the user to set up communications with the system. A static IP address must be assigned to the controller. Once the static IP address is assigned, it must be manually entered into the controller. The subnet and gateway is not needed when accessing the controller within a facility’s intranet. Once the static IP is entered, the user must press the “Set IP Parameters” button or cycle the power to the controller to ping the device on their intranet network. Communication through Ethernet includes Remote Access and MODBUS TCP/IP communication. A connection status message will indicate if a successful connection has been made.

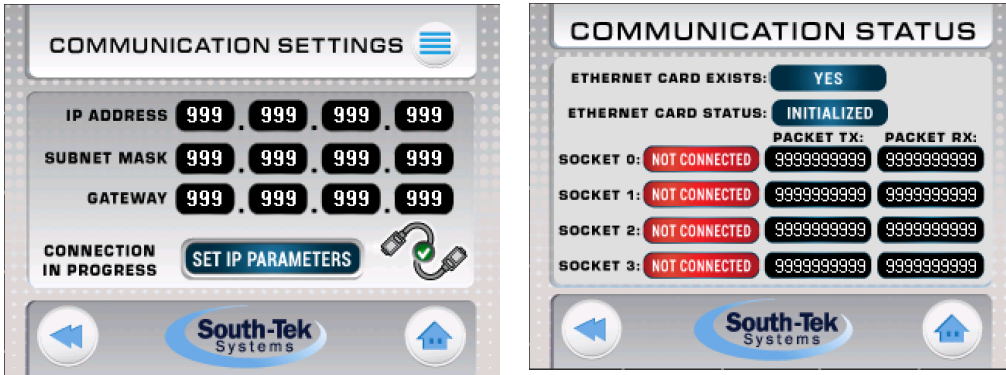

Figure 18: Communication Screens

7.18.1 Remote Access

A copy of the software setup files for this software will be included by South-Tek Systems upon request. This software can be installed on any windows-based PC with Windows 7 or higher. The user will have full access of the controller touchscreen as if the user was standing in front of the machine and using the mouse to navigate through the screens. To set up the connection to the controller, the communication settings on the computer must be set up to as the following:

1. Open the Remote Access Software and go to the “Configurations >Communication - PC settings”.
2. Select Connection Type: TCP/IP (Call)
3. Press the red folder to bring up the TCP/IP Addresses setup.
4. Enter static IP address assigned to the controller under “IP Address” column.
5. Select “TCP” under “Protocol” column.
6. Enter in the PLC Name (found on the 2nd page of this manual).
7. Press the “Get OPLC Information” to make sure the connection information is correct. An error message will appear if the information is not correct.
8. Press “Exit” once connection information has been confirmed.

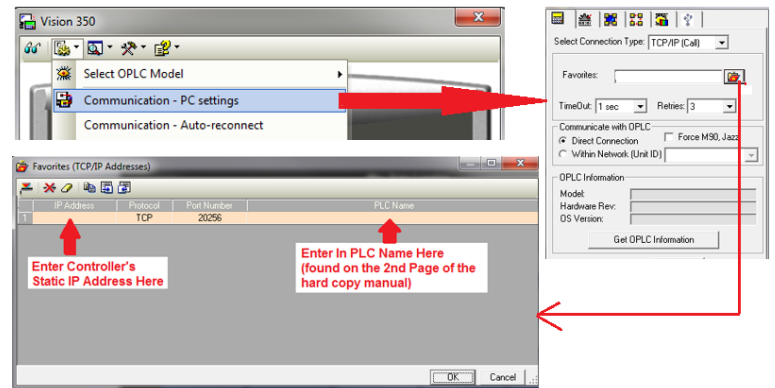

Figure 19: Remote Access Communication Setup

Loading Image File and Logging on

1. Open the Remote Access Software and go to the “Configurations > Select Fonts and Images file (*.urc)”.
2. Browse for the file “PLC Image File.urc” which is loaded onto the SD card.

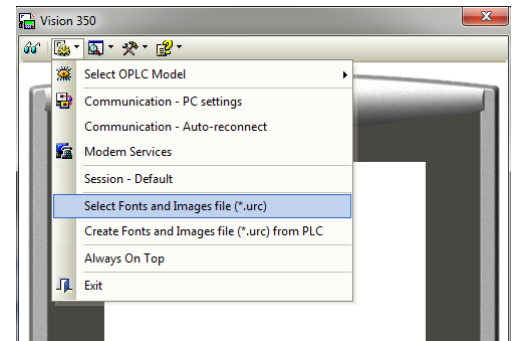

Figure 20: Loading Image File

- Press the “Glasses” icon in the left corner of the software to establish real time connection with the controller.

7.18.2 MODBUS Communication

Once the nitrogen generator is provided with a static IP addressed and can be seen on the network, MODBUS communication can be set up to retrieve real time data. All 32-bit registers below are read in little-endian format. The nitrogen generator MODBUS Communication settings are as follows:

- Protocol: TCP
- Local Port: 502
- PLC Controller: Slave

Coils		MODBUS Command Number	
Pointer Value From	Operand Type	Read	Write
0000	MB	#01 Read Coils	#15 Force Coils

See MODBUS addressing table below:

Registers		MODBUS Command Number	
Pointer Value From	Operand Type	Read	Write
0000	MI (16 Bit)	#03 Read Coils	#16 Preset Holding Registers

Table 2: MODBUS Addressing Table

Description of Coils	STS Controller Address	SCADA/Modbus Address Pointer	Format/Status	Read/Write
Start/Stop Generator	MB 12	00013	0=Off, 1=On	R/W
Nitrogen Load/Unload	MB 7	00008	0=Unloaded, 1=Loaded	R
Dry Air Load/Unload	MB 246	00247	0=Unloaded, 1=Loaded	R
Alarm (any enabled alarm)	MB 61	00062	0=Good, 1=Alarm	R
Low N2 Pressure Alarm	MB 106	00107	0=Good, 1=Alarm	R
High O2 Content Alarm	MB 0	00001	0=Good, 1=Alarm	R
Low Dry Air Pressure Alarm	MB 205	00206	0=Good, 1=Alarm	R
Troubleshooting Active	MB 111	00112	0=None Active, 1=Active	R
Particulate Filter Status	MB 14	00015	0=Good, 1=Change Needed	R
Coalescing Filter Status	MB 28	00029	0=Good, 1=Change Needed	R
Intake Filters Status	MB 29	00030	0=Good, 1=Change Needed	R
Low Battery Indicator	SB 8	20489	0=Good, 1=PLC Low Battery	R

Continued on following page.

Description of Registers (16-bit)	STS Controller Address	SCADA/Modbus Address Pointer	Format/Status	Read/Write
Nitrogen Storage Pressure	MI 118	40119	XXX.X PSIG	R
Oxygen Concentration (%)	MI 5	40006	XX.XX % O2	R
Dry Air Pressure	MI 161	40162	XXX.X PSIG	R
N2 Load Pressure Setpoint	MI 20	40021	XXX.X PSIG/kPa	R/W
N2 Unload Pressure Setpoint	MI 21	40022	XXX.X PSIG/kPa	R/W
Dry Air Load Pressure Setpoint	MI 3	40004	XXX.X PSIG/kPa	R/W
Dry Air Unload Pressure Stpt	MI 4	40005	XXX.X PSIG/kPa	R/W
Low N2 Pressure Alarm Point	MI 98	40099	XXX.X PSIG/kPa	R/W
O2% Alarm Point	MI 14	40015	XX.XX % O2	R/W
Low Dry Air Alarm Point	MI 122	40123	XXX.X PSIG/kPa	R/W

Description of Registers (32-bit)	STS Controller Address	SCADA/Modbus Address Pointer	Format/Status	Read/Write
Compressor Run Hours	ML 14	28700	XXXXXXXXXX Hours	R
Compressor Loaded Hours	ML 42	28756	XXXXXXXXXX Hours	R

8 NITROGEN GENERATOR OPERATIONS

This section describes the procedure for starting, running, and stopping the nitrogen generator. The operator should notify personnel in the area of the equipment start-up. Make sure the start-up will not interfere with other operations.

8.1 START-UP

This section describes the necessary steps of both the initial start-up and a normal routine start-up. If this is the first time the unit has been started, follow the Initial Start-up procedure.

8.1.1 Initial Start-Up

1. Verify that power connection is 208-230 V / 50 - 60 Hz / 1 PH as labeled on the unit and that the touchscreen on the generator is in the "Stopped" mode (the "start/stop" button in the lower right corner of the "Home" screen – red button indicates that the system is in stopped mode).

NOTE: During the start-up sequence, check for leaks in all pipe fittings and valves.

WARNING: Shut off air supply valve and depressurize the system before repairing any leaks.

2. Close the nitrogen out to process valve. Dual and Tri gas generators should also close dry air or zero air outlets.
3. On the nitrogen generator controller, press and hold the power button so that it toggles to green and the nitrogen generator should start cycling through valves and pressurizing the first bed.
4. Observe pressure gauges on the filter set for 10 minutes and make sure that the pressure swings from bed to bed every 45-90 seconds. This will be a full pressurization to 110-130 PSIG, pressure falls then builds to the target 110-130 PSIG.
5. Nitrogen will start to flow to the nitrogen storage tank and begin building pressure. Dual and Tri generators will also begin to build dry air pressure to the internal storage tank.
6. When the nitrogen storage pressure reaches the cut-out pressure, the system will go into "unload" mode, indicated on the "Home" screen and the nitrogen production will pause.
7. Now that the system is in "unload" mode, open the nitrogen outlet valve and the nitrogen storage tank will start losing pressure. Once the pressure falls to the "cut-in" pressure, the system will automatically restart and fill nitrogen into the storage tank again.

NOTE: When the nitrogen generator is turned on for the first time or after a prolonged shutdown period, some of the lines may have equalized and balanced the nitrogen and oxygen. Therefore, at the restart, the first few cycles of nitrogen being delivered to the storage tank may not be producing the design purity specification.

8.1.2 Normal Start-up

Follow this procedure to start the generator for normal operation. If this is the first time the unit has been started, follow the Initial Start-up procedure, 7.1.1.

1. Ensure the toggle the “start/stop” button to “start” (button should be illuminated green to indicate that the system has started).
2. Open any shut off valves in the product Nitrogen line to the user’s piping system. Allow the system purity to rise before using product.

NOTE: If the system outlet valve(s) has been opened to the atmosphere, the system must be purged of any residual bad gas. This applies to dry air and nitrogen outlet connections

8.2 SHUTDOWN

In case of an emergency, simply turn off the main power switch to the nitrogen generator. This will stop all generator functions immediately. Nitrogen supply can be shut off manually closing the gas outlet valve(s) located on the back of the product.

For normal shutdown, valve off the gas outlet valve(s) on the output of the unit. Then, toggle the “Start/Stop” button to off on the “Home” screen.

WARNING: The generator will remain pressurized after shutting it down. Before performing any maintenance or opening any piping systems, always depressurize the system. Failure to do so may result in injuries.

9 SYSTEM MAINTENANCE

9.1 LABTEK™ N2-70 SERIES

Whenever performing any maintenance to the system, make sure to power down the system and close all external valves. Remove the front cover to gain access to the filters.

9.1.1 Air Intake Filters

The integrated air compressor has (1) intake filter. They are designed to prevent particles from entering the compressor housing and damaging internal components. These filters need to be replaced every 4000 hours or once per year (whichever comes first). To do so the unit must be shut down. It is potentially harmful to replace this element without stopping the compressor first. Remove the filter by twisting the back piece from the filter base. A twist counterclockwise will reveal the filter element. Remove the old element and vacuum the element, replace the element if the paper remains dirty or there are any tears in the paper. Use a clean dry cloth to clean the filter housing before installing the new element.

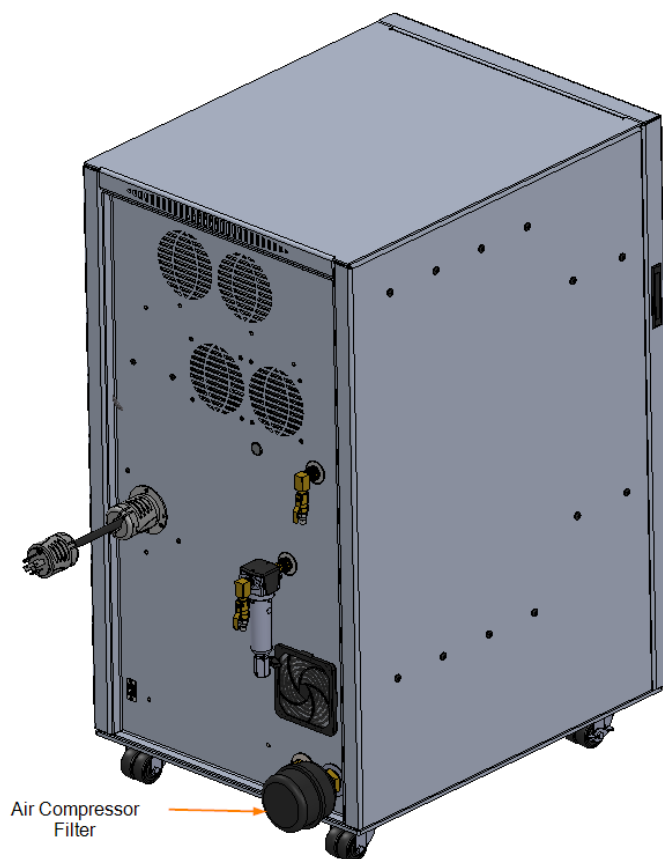

Figure 21: LABTEK™ N2-70 Series Air Compressor Filter Locations

9.2 PARTICULATE AND COALESCING FILTER

The particulate and coalescing filter after the air compressor captures particulate and moisture prior to entering the rest of the system. These filters need to be replaced once per year. To do so:

1. Power off the equipment and make sure there is no pressure on the filter bowls. The gauge on the filter bowl will read 0 PSIG to indicate that there is no pressure on the bowl.
2. Unscrew the filter bowls by turning them counterclockwise. (Use boxed end wrench on filter bowl base for easier removal)
3. Once the filter bowls have been removed, rinse any debris out of the bowls with warm water.
4. Dry and clean the bowls with a clean dry cloth.
5. The particulate element can be removed by pulling the element downward by hand; then replaced with the new element in the reverse order.
6. The coalescing element can be removed by pulling the element downward by hand; then replaced with the new element in the reverse order.
7. Once both elements have been replaced, bowls have been cleaned and O-rings replaced, the bowls can be screwed back into their corresponding filter housings.

Once all the filters have been replaced, press and hold the filter reset buttons in the PLC and audible buzzer confirms the reset. Put the front cover back on the cabinet and the unit can be powered up again. Once powered up, you should hear the air compressor turn on and the LABTEK™ gas generator will be producing nitrogen and/or dry air. Be sure to check the filter bowls for leaks. The filter alarm and filter change timer can also be reset using the controller buttons on the side of the unit near the fan (see: **7.14 Filter Change**)

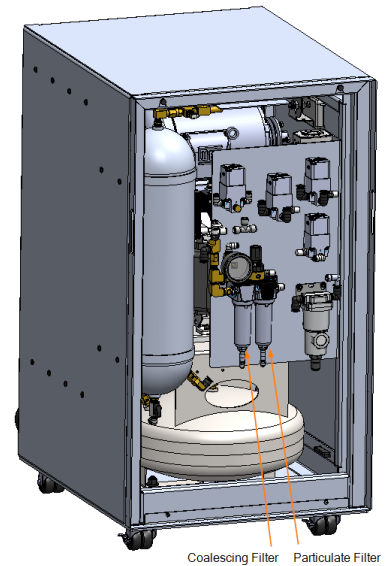

Figure 22: LABTEK™ N2-70 Series Compressed Air Filtration

9.3 ACTIVATED CARBON FILTER

For LABTEK gas generators an activated carbon filter is included for nitrogen and zero air outlets. The activated carbon filter removes volatile organic compounds, odors, and other gaseous pollutants from the gas outlets.

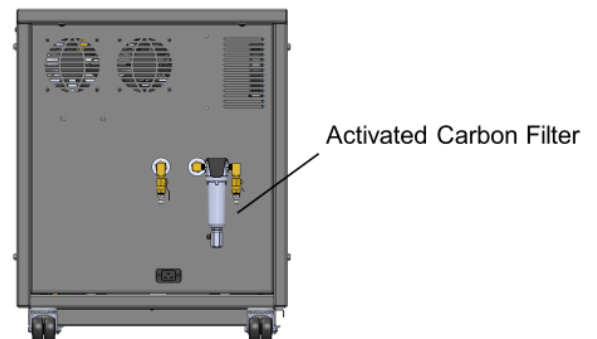

Figure 23: Activated Carbon Filter

9.4 LABTEK™ N2-70 SERIES FILTER REPLACEMENT

All units come equipped with a standard filter set that includes a particulate, coalescing, and intake filters. Clean filter elements are important for good system performance. Factory recommendation on filter change out schedule are as follows:

- Particulate: every 12 months (1 per year)
- Coalescing: every 12 months (1 per year)
- Activated Carbon: every 12 months or as needed basis (1 per year)
- Intake Filters: every 4000 hours or 12 months (up to 2 per year)

Annual Filter replacement kit part # FRP-016 (70L/90D), FRP-017 (70T)



Item #	Description	Service	FRP-016		FRP-017
			70L	90D	70T
1	Particulate Filter	Air Polishing	1		1
2	Coalescing Filter	Air Polishing	1		1
3	Activated Carbon Filter	N2 out final filtration, HC removal	1		2
4	Intake Filter	Intake Air Polishing	2		2

WARNING: Do not try to remove filter bowls unless both the air supply gauge clearly read zero psig. Valve off the incoming supply. Relieve system pressure by turning off the unit, If applicable open the manual drain relief on the bottom of the bowl (1/4 turn valve).

1. Disconnect the tubes from the bottom of the bowls.
2. To remove the bowls from the 70 series, apply a 13/16" boxed in or flare nut wrench to the bottom of the bowl.
3. Inspect the bowls. If the drain system is working properly, the bowls should not be full of water.
4. Remove the filter element by pulling straight down. Take notice of how the element looks. If the element is excessively dirty, more frequent filter changes may be recommended.

NOTE: A plugged drain system will cause water to carry over into the system. This may cause permanent damage to the media inside the nitrogen generator. Such damage is not covered by the manufacturer's warranty. Use of filters other than those specified by South-Tek Systems could result in damages not covered by the warranty.

5. Wash the bowls in soapy water and rinse thoroughly as needed. Use of light air gun to remove debris is also acceptable. Make sure to always clean and dry with a clean and dry cloth.
6. Install new filter element and replace O-rings as needed.
7. Put the filter bowl back on the system opposite of how it was removed making sure the bowl is seated in place correctly.
8. Reconnect the drain tubes.
9. Press and hold the system start button, ensure proper pressurization per the start up procedure.

10 KEY CONTACTS

For any questions with the performance and/or maintenance of the system, contact:

South-Tek Systems

3700 U.S. Hwy 421, Wilmington, NC 28401

Phone: 1-(888)-526-6284

Email: info@southteksystems.com

Visit: www.southteksystems.com

11 FAQs

11.1 POWER ISSUES

If the LABTEK™ N2-35 Series & LABTEK™ N2-70 Series does not have power, the production and storage of nitrogen will become apparent once the storage pressure drops.

1. Check the power cable
2. Has the building's circuit breaker or internal breaker tripped? Locate the breaker and reset. If the breaker continues to trip, you may have that circuit overloaded.

11.2 PRESSURE ISSUES

The LABTEK™ N2-70 Series will produce and store nitrogen at 105 (+/-3) psig. Once the storage builds pressure the system will go into unload mode. When the pressure drops by about 7-13 psig, the system should go into load mode and begin to refill the storage. If the system is out of the specifications contact the manufacturer or factory trained technician.

11.2.1 Nitrogen Pressure Check:

Look at the digital pressure readout on the PLC. It should be between 105 and 125 psig. If the pressure is low, a few things need to be checked.

- Check for leaks throughout the system.

11.2.2 Pressure Regulation Check:

A primary regulator is usually installed on the output lines coming from the LABTEK™ N2-35 Series & LABTEK™ N2-70 Series. The primary regulator is there to "step down" the available pressure. Supplied regulators should also normalize pressure and decrease point of use variation in pressure. There are sometimes secondary regulators located at point of use. The secondary regulators are typically per manufacturer or site specification, if applicable.

11.3 GAS LEAKS

As with any gas system, only use a spray bottle on non-electrical equipment to find leaks. Fix or replace leaking fittings or old hose. Push-to-connect fittings will show bubbles and typically have up to a 5ccm acceptable leakage rate. Contact your local provider/installer for help.

11.4 GENERAL ISSUES

Symptoms	Probable Cause	Corrective Action
Nitrogen Generator Not Cycling	Low Voltage/Amperage	Check Electrical Source
	Circuit breaker tripped	Reset supply circuit breaker
	Breaker Tripped	Reset breaker on electrical panel
	System is OFF (Lower right button on Home screen is Red)	Touch the Red switch for 2 seconds until it turns green
	Defective Wiring	Check all wiring connections
Running Continuously During no Nitrogen Demand	Incorrect unload pressure setpoint	Set unload pressure to factory setting
	Defective wiring with pressure transducer to the Touchscreen	Check the wiring connections
	Excessive N2 Leakage	Correct all N2 leakage
	Clogged inlet air filter	Clean filter with vacuum or replace element
High O2 content	Product flow is too high	Decrease product flow
	O2 analyzer malfunction	Replace O2 analyzer
	O2 flow port valved off	Open the O2 sample port
	Exhaust port plugged	Check exhaust muffler is not blocked
	Clogged inlet air filter	Clean filter with vacuum or replace element
System not building gas pressure	Bad solenoid valve	Check each individual valve is working properly.
	Defective wiring	Check all wiring
	Disconnected pneumatic line	Check all pneumatic lines for leakage and proper connection based on South-Tek Systems' guidelines
	Closed valve	Ensure all valves to tank are in the open position
	Clogged inlet air filter	Clean filter with vacuum or replace element

APPENDIX A: WARRANTY

The LABTEK™ N2-35 Series & LABTEK™ N2-70 Series are warrantied against any defects in workmanship and materials for 12 months from the date of shipment from South-Tek Systems unless otherwise specified by South-Tek Systems. The purchaser has the liability to ensure that the system is fully inspected upon delivery and shall contact the appropriate shipping company to make any claims on damaged goods due to transit within that shipping company's policies. If the system is received with defects that are not due to shipping, a written claim should be submitted to South-Tek Systems within 1 week of receiving the shipment. South-Tek Systems can deny all other claims at their discretion.

All warranty work shall be done at a South-Tek System facility or by a LABTEK™ N2-35 Series & LABTEK™ N2-70 Series Authorized Service Provider. Only factory trained and authorized personnel are covered under warranty. Any part that is returned / repaired / replaced under warranty may be remanufactured or changed to a different specification at the factory's option. Any work performed by an unauthorized person/company or usage of non-factory parts, may void all warranties to the product.

Any item not manufactured by South-Tek may carry its own warranty from its manufacturer and will be warrantied by that manufacturer. All parts that need to be returned should be announced. Any item(s) that is returned to South-Tek Systems without an RMA number (return authorization number) may be denied and returned to the sender. Contact the factory for RMA #'s, prior to return shipment.

South-Tek Systems is not liable for damages caused by normal wear and tear, water, fire, erosion, corrosion, explosion, misuse, oil/gas vapors, or unauthorized modifications. South-Tek Systems is also not liable for any losses, damages, or cost of delays, including incidental or consequential damages. There are no warranties or guarantees, expressed or implied, including the warranties of merchantability or fitness for a particular purpose or use, other than those warranties expressed herein.

For Claims, contact South-Tek Systems LLC at:

Tel: (888)526-6284

Email: service@southteksystems.com

Or write to:

South-Tek Systems, Warranty Claims, Highway 421 North Wilmington, NC 28401

